

# D7 % \$ ( ' j %%% Installation Guide

**PowerSeries**<sup>™</sup>  
SECURITY SYSTEM



**WARNING:** This manual contains information on limitations regarding product use and function and information on the limitations as to liability of the manufacturer. The entire manual should be carefully read.

## SAFETY INSTRUCTIONS for SERVICE PERSONNEL

**WARNING:** When using equipment connected to the TELEPHONE NETWORK, there are basic safety instructions that should always be followed. Refer to the SAFETY INSTRUCTIONS provided with this product; save them for (future) reference. Instruct the end-user regarding the safety precautions that shall be observed when operating this equipment.

### Before Installing The Equipment

Ensure your package includes the following items:

- Installation and User Manuals
- PC1404 alarm controller
- Power supply, direct plug-in
- Mounting hardware

#### ***READ and SAVE These Instructions!***

Follow All WARNINGS AND INSTRUCTIONS specified within this document and/or on the equipment.

### Selecting A Suitable Location For The Alarm Controller

Use the following list as a guide to find a suitable place for this equipment:

- Locate near a telephone socket and power outlet.
- Select a place free from vibration and shocks.
- Place the alarm controller on a flat, stable surface and follow the installation instructions.

DO NOT locate this product where persons may walk on the secondary circuit cable(s).

DO NOT connect the alarm controller to electrical outlets on the same circuit as large appliances.

DO NOT select a place that exposes your alarm controller to direct sunlight, excessive heat, moisture, vapors, chemicals or dust.

DO NOT install this equipment near water. (e.g., bath tub, wash bowl, kitchen/laundry sink, wet basement, near a swimming pool).

DO NOT install this equipment and its accessories in areas where there is a risk of explosion.

DO NOT connect this equipment to electrical outlets controlled by wall switches or automatic timers;

**AVOID** interference sources.

**AVOID** setting up the equipment near heaters, air conditioners, ventilators, and/or refrigerators.

**AVOID** locating this equipment close to or on top of large metal objects (e.g., metal wall studs).

### SAFETY Precautions Required During Installation

- **NEVER** install this equipment and/or telephone wiring during a lightning storm.
- **NEVER** touch uninsulated telephone wires or terminals unless the telephone line has been disconnected at the network interface.
- Position cables so that accidents cannot occur. Connected cables must NOT be subject to excessive mechanical strain.
- Use only the power supply provided with this equipment. Use of unauthorized power supplies may cause damage.
- For direct plug-in versions, use the transformer supplied with the device.

**WARNING:** THIS EQUIPMENT, WHEN POWERED VIA DIRECT PLUG-IN TRANSFORMER, HAS NO MAINS ON/OFF SWITCH. THE PLUG OF THE DIRECT PLUG-IN POWER SUPPLY IS INTENDED TO SERVE AS THE DISCONNECTING DEVICE IF THE EQUIPMENT MUST BE QUICKLY DISCONNECTED. IT IS IMPERATIVE THAT ACCESS TO THE MAINS PLUG AND ASSOCIATED MAINS SOCKET/OUTLET IS NEVER OBSTRUCTED.

#### **IMPORTANT NOTE!**

This equipment, alarm controller PC1404, shall be installed and used within an environment that provides the pollution degree max 2 and over-voltages category II NON-HAZARDOUS LOCATIONS, indoor only. The equipment is FIXED and PERMANENTLY CONNECTED and is designed to be installed, serviced and/or repaired by service persons only; [service person is defined as a person having the appropriate technical training and experience necessary to be aware of hazards to which that person may be exposed in performing a task and of measures to minimize the risks to that person or other persons]. There are no parts replaceable by the end-user within this equipment. The wiring (cables) used for installation of the Alarm System and accessories shall be insulated with PVC, TFE, PTFE, FEP, Neoprene or Polyamide.

a) The equipment enclosure must be secured to the building structure before operation.

b) Internal wiring must be routed in a manner that prevents

- excessive strain or loosening of wire on terminal connections;

- damage of conductor insulation.

c) Disposal of used batteries shall be made in accordance with local waste recovery and recycling regulations.

d) Before servicing, DISCONNECT the power and telephone connection.

e) DO NOT route any wiring over circuit boards. Maintain at least 1" (25.4 mm) separation.

f) It is the installer's responsibility to ensure that a readily accessible disconnect device is incorporated in the building for permanently connected installations.

g) The connection to the mains supply must be made as per the local authorities' rules and regulations. An appropriate disconnect device must be provided as part of the building installation. Where it is not possible to rely on identification of the neutral in the AC Mains supply, the disconnecting device must disconnect both poles simultaneously (line and neutral). The device shall disconnect the supply during servicing.

The power supply must be Class II, FAIL SAFE with double or reinforced insulation between the PRIMARY and SECONDARY circuit/ ENCLOSURE and be an approved type acceptable to the local authorities. All national wiring rules shall be observed.

# Guidelines for Locating Smoke & CO Detectors

The following information is for general guidance only and it is recommended that local fire codes and regulations be consulted when locating and installing smoke and CO alarms.

## Smoke Detectors

Research indicates that all hostile fires in homes generate smoke to a greater or lesser extent. Detectable quantities of smoke precede detectable levels of heat in most cases. Smoke alarms should be installed outside of each sleeping area and on each storey of the home. DSC recommends that additional smoke alarms beyond those required for minimum protection be installed. Additional areas that should be protected include: the basement; bedrooms, especially where smokers sleep; dining rooms; furnace and utility rooms; and any hallways not protected by the required units.

On smooth ceilings, detectors may be spaced 9.1m (30 feet) apart as a guide. Other spacing may be required depending on ceiling height, air movement, the presence of joists, uninsulated ceilings, etc. Consult National Fire Alarm Code NFPA 72, CAN/ULC-S553-02 or other appropriate national standards for installation recommendations.

- Do not locate smoke detectors at the top of peaked or gabled ceilings; dead air space in these locations may prevent smoke detection.
- Avoid areas with turbulent air flow, such as near doors, fans or windows. Rapid air movement around the detector may prevent smoke from entering the unit.
- Do not locate detectors in areas of high humidity.
- Do not locate detectors in areas where the temperature rises above 38°C (100°F) or falls below 5°C (41°F).

Smoke detectors should always be installed in USA in accordance with Chapter 29 of NFPA 72, the National Fire Alarm Code: 29.5.1.1. Where required by other governing laws, codes, or standards for a specific type of occupancy, approved single- and multiple-station smoke alarms shall be installed as follows:

- (1) In all sleeping rooms and guest rooms.
- (2) Outside of each separate dwelling unit sleeping area, within 21 ft (6.4 m) of any door to a sleeping room, with the distance measured along a path of travel.
- (3) On every level of a dwelling unit, including basements.
- (4) On every level of a residential board and care occupancy (small facility), including basements and excluding crawl spaces and unfinished attics.
- (5) In the living area(s) of a guest suite.
- (6) In the living area(s) of a residential board and care occupancy (small facility).

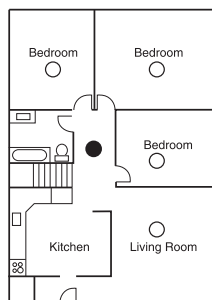

Figure 1

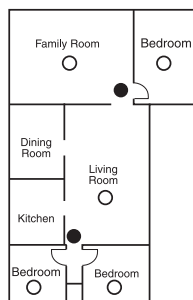

Figure 2

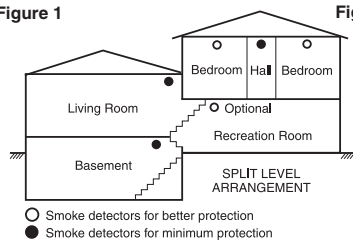

Figure 3a

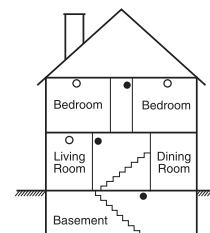

Figure 3

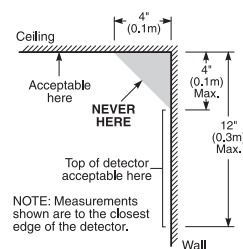

Figure 4

## CO Detectors

CO gas moves freely in the air. The human body is most vulnerable to the effects of CO gas during sleeping hours. For maximum protection, a CO alarm should be located outside primary sleeping areas or on each level of your home. Figure 5 indicates the suggested locations in the home. The electronic sensor detects carbon monoxide, measures the concentration and sounds a loud alarm before a potentially harmful level is reached.

Do **NOT** place the CO alarm in the following areas:

- Where the temperature may drop below -10°C or exceed 40 °C.
- Near paint thinner fumes.
- Within 5 feet (1.5 meters) of open flame appliances such as furnaces, stoves and fireplaces.
- In exhaust streams from gas engines, vents, flues or chimneys.
- Do not place in close proximity to an automobile exhaust pipe; this will damage the detector.

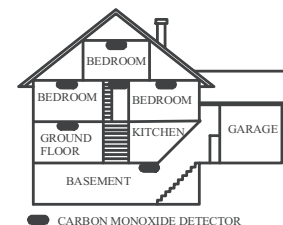

Figure 5



# Table of Contents

SAFETY INSTRUCTIONS for SERVICE PERSONNEL .....	ii
1 Introduction .....	1
1.1 Compatibility Requirements .....	1
1.2 Product Specifications .....	1
1.3 Out of the Box .....	2
2 Installation .....	3
2.1 Installation Steps .....	3
2.2 Terminal Descriptions .....	3
2.3 Wire Routing for Power & Non-Power Limited .....	4
2.4 Keybus Operation and Wiring .....	4
2.5 Current Ratings – Modules & Accessories .....	5
2.6 Keypad Assignment .....	5
2.7 Supervision .....	5
2.8 Removing Modules .....	5
2.9 Zone Wiring .....	5
2.10 Zone Doubling .....	6
2.11 Fire Zone Wiring .....	7
2.12 CO Detector Wiring .....	7
2.13 Keypad Zones .....	7
3 Keypad Commands .....	10
3.1 Arming and Disarming .....	10
3.2 Auto Bypass – Stay Arming .....	10
3.3 Automatic Arming .....	10
3.4 Night Arming .....	10
3.5 [*] Commands .....	10
4 Programming .....	16
4.1 Installer Programming .....	16
4.2 Programming Decimal Data .....	16
4.3 Programming HEX Data .....	16
4.4 Programming Toggle Option Selections .....	17
4.5 Viewing Programming .....	17
4.6 DLS Programming .....	17
5 Programming Worksheets .....	18
5.1 Index to Programming Worksheets .....	18
5.2 Programming Worksheets .....	19
6 Testing & Troubleshooting .....	34
Appendix A: Reporting Code Formats .....	37
Appendix B: Communicator Format Options .....	40
Appendix C: Regulatory Approvals Information .....	42
Appendix D: New Zealand Addendum .....	45
Appendix E: Australian Addendum .....	46
Appendix F: Addendum for Installations in South Africa .....	48

# PC1404 Wiring Diagram

Test the alarm system at least once per week.

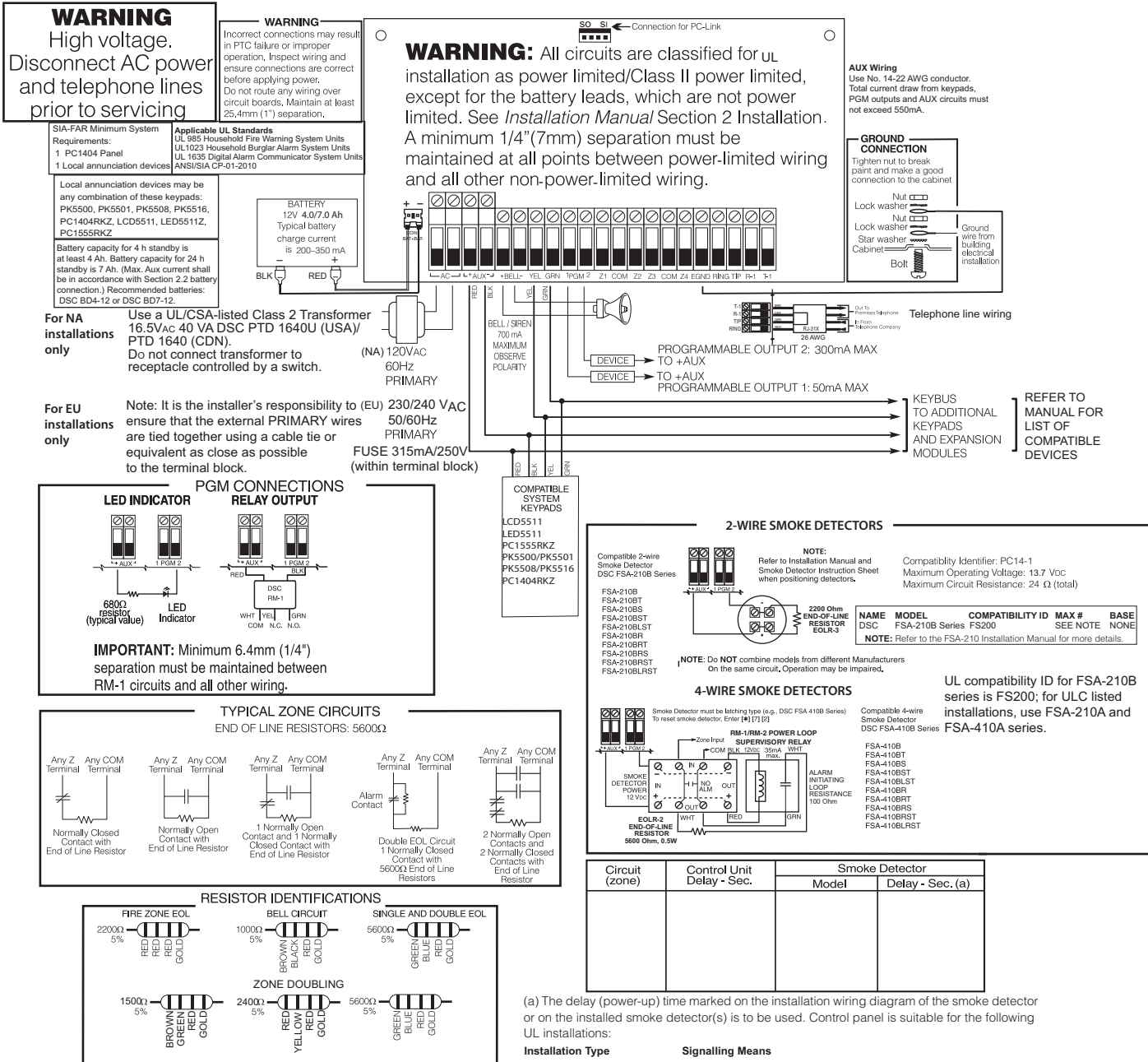

**WARNING-** Not to be removed by anyone except occupant: This equipment should be installed in accordance with the ANSI/NFPA 72 (National Fire Protection Association, Batterymarch Park, Quincy MA, 02269). Printed information describing proper installation, operation, testing, maintenance, evacuation planning, and repair service is to be provided with this equipment.

Temperature Range: 0-49°C (32-120°F) (for UL/ULC applications)  
 Maximum Humidity: 85% R.H.  
 Refer to the *Installation Guide* (29008503) and *User Manual* (29008622) for complete operating instructions.  
 The PC1404 is UL listed for limited energy installations per NEC Article 760. Recognized limited energy cable should be used. Observe NEC wiring requirements and local codes defined by the authority having jurisdiction.  
 Security detection devices that require power from the control panel must operate over the range of 11.1-12.6 VDC

(a) The delay (power-up) time marked on the installation wiring diagram of the smoke detector or on the installed smoke detector(s) is to be used. Control panel is suitable for the following UL installations:

Installation Type	Signalling Means
Resi Fire Burg	DACT

This device complies with Parts 15 and 68 of the FCC rules. Operation is subject to the following two conditions: (1) this device may not cause harmful interference, and (2) this device must accept any interference received, including interference that may cause undesired operation.

US: F53AL01BPC1404 REN = 0.1B Plug Type: RJ-31X  
 IC:160A-PC1404

In Canada, the PC1404 is listed for Residential Fire and Burglary installations. The product shall be installed as per UL-S540 and ULC-S310 Standards.  
 MADE IN CANADA  
 Digital Security Controls  
 Toronto, Canada

**WARNING:** Incorrect connection of batteries may result in battery rupture or fire hazard. Do NOT allow metal objects to connect the positive and negative terminals. Ensure that batteries are connected with correct polarity [Red to (+), Black to (-)]. Failure to comply with this may result in battery rupture and/or fire hazard.

**THIS UNIT INCLUDES AN ALARM VERIFICATION FEATURE THAT WILL RESULT IN A DELAY OF THE SYSTEM ALARM SIGNAL FROM THE INDICATED CIRCUITS. THE TOTAL DELAY (CONTROL UNIT PLUS SMOKE DETECTORS) SHALL NOT EXCEED 60 SECONDS. NO OTHER SMOKE DETECTOR SHALL BE CONNECTED TO THESE CIRCUITS UNLESS APPROVED BY THE LOCAL AUTHORITY HAVING JURISDICTION. Note: Alarm Verification is not supported for 2-wire interface, only 4-wire.**

North America Only

1. Insert Stand off into cabinet mounting hole in the desired location. Snap-in-place.
2. Position circuit board mounting holes over standoffs. Press firmly on board to snap-in-place.

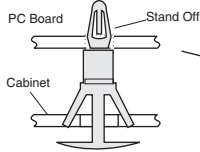

Primary: 120VAC/60Hz.  
 Secondary: 16.5VAC 40VA  
 DSCPTD 1640U  
 Class II Transformer

NOTE: Do not connect transformer to receptacle controlled by a switch

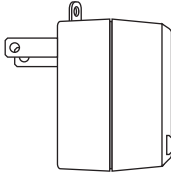

230/240 VAC 50/60 Hz International

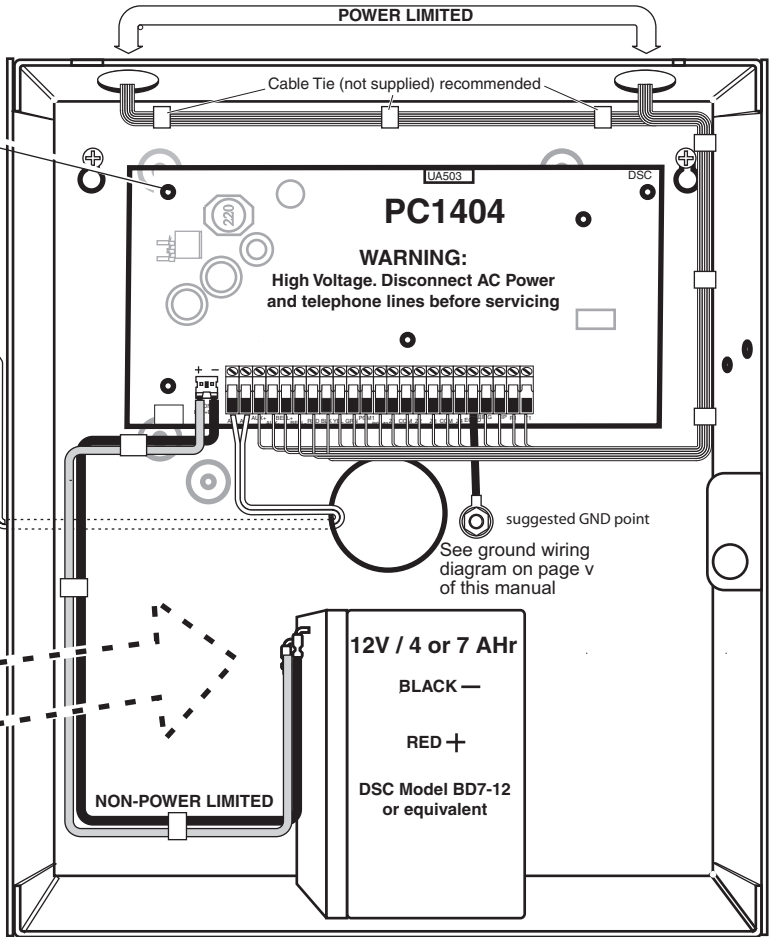
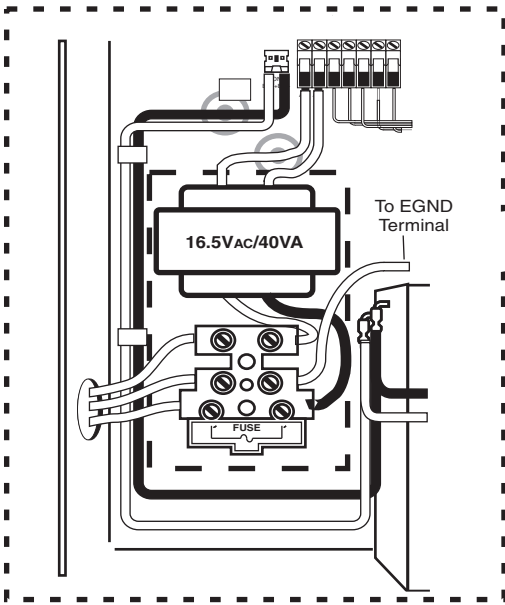

**WARNING:** Incorrect connections may result in PTC failure or improper operation. Inspect wiring and ensure connections are correct before applying power.

Incorrect connection of batteries may result in battery rupture or Fire Hazard. Do NOT allow metal objects to connect the Positive and Negative Terminals. Ensure that batteries are connected with correct polarity [Red to (+), Black to (-)]. Failure to comply with this may result in battery rupture and/or Fire Hazard. All circuits are classified for UL Installations as Power Limited/Class II Power Limited except for battery leads which are not power limited.

Do NOT route any wiring over circuit boards. Maintain at least 1" (25.4mm) separation. A minimum of 1/4" (6.4mm) separation must be maintained at all points between power limited wiring and all other non-power limited wiring.

IMPORTANT:

- This equipment, Alarm Controller PC1404 shall be installed and used within an environment that provides the pollution degree max 2 and overvoltages category II NON-HAZARDOUS LOCATIONS, indoor only. The equipment is FIXED and PERMANENTLY connected and is designed to be installed by service persons only; [service person is defined as a person having the appropriate technical training and experience necessary to be aware of hazards to which that person may be exposed in performing a task and of measures to minimize the risks to that person or other persons.]
- The connection to the mains supply must be made as per the local authorities rules and regulations. An appropriate disconnect device must be provided as part of the building installation. Where it is not possible to rely on identification of the neutral in the AC Mains supply the disconnecting device must disconnect both poles simultaneously (line and neutral). The device shall disconnect the supply during servicing.
- The equipment enclosure must be secured to the building structure before operation.
- Internal wiring must be routed in a manner that prevents:
  - Excessive strain on wire and on terminal connections;
  - Loosening of terminal; connections;
  - Damage of conductor insulation
- Disposal of the used batteries shall be made according to the waste recovery and recycling regulations applicable to the intended market.

**WARNING:**  
 High Voltage. Disconnect AC Power  
 and telephone lines before servicing

## 1 Introduction

This manual provides installation and programming information for the PC1404 four-zone panel security system.

### 1.1 Compatibility Requirements

The PC1404 product is the central component of the four-zone security system. Interaction with associated system devices is hardwired, which follows DSC keybus standards. Communications with the central station may be achieved by a hardwired phone line. DLS may also be remotely connected to the panel via phone line or locally connected via the PC-Link header. Shown below are the supported and unsupported modules for the PC1404.

**Note:** All necessary information required to meet UL listing requirements is included in this document.

Table 1-1 Supported Modules

Module	Current Draw, mA	Software Versions
PC1404RKZ Keypad*	120	1.0
PK5500/PK5501/PK5508/PK5516 Keypads*	125	1.0, 1.1, 1.2, 1.3
LCD5511 Fixed Message LCD Keypad*	85	1.0
LED5511 8-Zone LED Keypad*	100	1.0
PC1555RKZ 8-Zone LED Keypad*	85	2.0
PC5200 Power Supply*	20	2.0
PC5204 Power Supply with 4 PGMs*	20	2.0
PC5208 Low Current PGM Module*	20	1.0
PC5601 LED Status Module	30	1.0
TL300 T-Link TL300 IP Alarm Communicator*	360	1.2-1.5
GS3060 GPRS Universal Cellular Alarm Communicator*	120	3.1, 3.2
3G3070 HSPA (3G) Universal Cellular Alarm Communicator*	120	3.5
GS3105/3125-K & BA Wireless Alarm Communicator	250 (excluding outputs)	3.0

\*UL/ULC-listed devices.

**Note:** For UL/ULC-listed installations, use only UL/ULC-listed devices.

**Note:** For SIA CP-01: 2010 compliant installations, the minimum required components are: PC1404 Control Panel and PC1404RKZ keypad. Optional components that can be used with the system are: PK55XX series keypad. These keypads can only be used for SIA CP-01: 2010 Compliant installations if the emergency keys are not enabled.

Table 1-2 Unsupported Modules

Module	
PC5100 2-wire interface	PC5964 Large Audio Station
RFK55XX Keypad	PC5401 RS232 Module
RF5132-433 Wireless Receiver	PC5400 Printer + DVACS
RF5108-433 Wireless Receiver	Escort 5580 Telephone Interface
PC5108 Zone Expander	TL260 Series Communicators
PC5320 Zone Expander	GS2060 Series Wireless Alarm Communicator
PC5950 Audio Module	TL250 Communicator
PC5904 Large Audio Station	TL150 Communicator
PC5921 Audio Station	IT100 Integration Module
PC5961, PC5962 Small Audio Station	IT120 Integration Module
PTK5507 Touchscreen keypad	

Table 1-3 Compatible Smoke Detector Models

4-Wire Smoke Detectors	2-Wire Smoke Detectors
FSA-410x	FSA-210x
FSA-410xT	FSA-210xT
FSA-410xS	FSA-210xS
FSA-410xST	FSA-210xST
FSA-410xLST	FSA-210xLST
FSA-410xR	FSA-210xR
FSA-410xRT	FSA-210xRT
FSA-410xRS	FSA-210xRS
FSA-410xRST	FSA-210xRST
FSA-410xLRST	FSA-210xLRST

**Note:** For model numbers above, x = A (ULC); x = B (UL); x = C (CE)

## 1.2 Product Specifications

### Control and Indicating Equipment Specifications

#### Features

- Supports zone doubling — supervised and distinguishable
- NC/Single/Double EOL support



- Supports up to 4 keypads
- 1 Partition support
- 128 events
- Communications: on-board PSTN
- 4 phone numbers
- 2-wire and 4-wire smoke detector support
- Auto-arming

### Zone Configuration

- 31 zone types and 11 programmable zone attributes
- Supports up to 4 hardwired NC, SEOL, DEOL zones, expandable to 8 with the zone doubling feature
- Keypad zones allow the system to be configured to support 8 zones—4 onboard zones and up to 4 keypad zones

### Access Codes

- Supports 39 user codes and 1 master code
- 6 programmable user code attributes; see PC1404 User Manual for details
- Duress codes derived from user codes  $\pm$  1 digit are not allowed

### Programmable Outputs (PGMs)

- Up to an additional 12 PGMs are supported with PGM expander for a total of 14 PGMs on the system
- 24 PGM types
- PGM 1: 50mA switched
- PGM 2: 300mA current-limited switched. This PGM supports compatible 2-wire smoke detectors (90mA current limited)

### Power Supply

- 1.5A regulated
- Panel current draw:
  - 240 VAC Primary.....180 mA(AC)(Max.)
  - 120 VAC Primary.....330 mA(AC)(Max.)
  - 16.5 VAC Secondary.....1.5A(AC)(Max.)
- Nominal panel current draw: 85mA
- 550mA Auxiliary Supply, 11.1-12.5VDC (12VDC nominal)
- Positive Temperature Coefficient (PTC) for BELL, AUX+ and battery terminals
- Reverse Battery Detection/Protection
- Supervision for loss of AC power and low battery
- Output ripple voltage 85mV p-p (Max.)

### Power Requirements

- AC Transformer Requirements:
  - Primary = 120VAC, 50/60Hz, 0.33A
  - Secondary = 16.5VAC, 40VA (North American market)
  - DSC PTD1640U (UL); DSC PTC1640 (ULC).
  - Primary = 230/240VAC, 50/60Hz, 0.21A
  - Secondary = 16.5VAC, 40VA (Australian, South African, International markets)
- Transformers must be Energy Efficient as per the local rules and regulations
- High-efficiency transformer for Australia

### Battery

- 12V sealed lead acid battery
- Charging mechanism supports 4Ah, 7Ah batteries
- Charging rate: 240mA (12 hrs Max.)
- Range for the charge current: 200mA–350mA
- Backup time: 24 hrs (use 7Ah battery) or 4 hrs (use 4Ah battery)
- Replace battery every 3–5 years.
- Low battery trouble indication threshold 11.25VDC
- Low battery trouble restore threshold 11.75VDC
- Battery deep discharge protection: fixed at 9.6V

### Aux+:

- Voltage: 11.1–12.5VDC
- Current: 550mA (Max.)

**Note:** Aux and PGM outputs share the 550mA load.

### Keybus Terminals

- Clock: yellow
- Data: green

### Memory

- 32Kbit serial CMOS EEPROM with write protection
- Retains programming and system status on AC or battery failure
- Data retention: 20 years min.

### Bell Output

- 12V, 700mA supervised (1k $\Omega$ ) bell output (current limited at 2A)
- Steady (for burglary), pulsed or temporal three (for Fire), temporal four (for CO) alarm cadences supported
- Bell short detection

### Operating Environmental Conditions

- Temperature range: 0°C to 49°C (32°F-120°F)
- Relative humidity: 85% noncondensing

### Telco Terminals

Ring	R-1
Tip	T-1

- Ring detection: 30V RMS min
- Protection for high ring voltage - Sidactor

### PCB Dimensions

- Length: 153 mm (6.0")
- Width: 94 mm (3.7")
- Height (tallest component): 28 mm (1.1")

### System Supervision Features

The PC1404 continuously monitors a number of possible trouble conditions and provides audible and visual indication at the keypad. Trouble conditions include:

- AC Power Failure
- Fire Trouble
- Telephone Line Trouble
- Low Battery Condition
- Bell Circuit Trouble
- General System Trouble (indicates peripheral module trouble)
- General System Tamper (indicates peripheral module tamper)
- Loss of System Time
- Tamper by Zone
- Failure to Communicate

### False Alarm Prevention Features

- Audible Exit Delay
- Audible Exit Fault
- Communication Delay
- Entry Delay Urgency
- Quick Exit
- Cross Zone Burglary Alarm
- Rotating Keypress Buffer

### Cabinets

Several cabinets are available for the PC1404, as follows:

#### PC5003C Cabinet

Cabinet for the PC1404 alarm controller. Dimensions (approximate): 288mm x 298mm x 78mm/11.3"x 11.7" x 3"

#### PC500C Cabinet Household Fire and Burglary

Cabinet for the PC1404 alarm controller. Dimensions (approximate): 213mm x 235mm x 78mm/8.4" x 9.25" x 3.0"

### 1.3 Out of the Box

Verify that the following components are included in your system:

- one PC500C cabinet
- one PC1404 main control circuit board
- one Installation Manual with programming worksheets
- one PC1404 Quick Reference Guide
- one hardware pack consisting of:
  - one 2-wire battery harness; L=34cm black & red
  - four 3/8" nylon standoffs; locking PCB support
  - eight 5600 $\Omega$  (5.6K) 1/2W 5%TR resistors
  - eight 1500 $\Omega$  (1.5K) 1/2W 5%TR resistors
  - four 2400 $\Omega$  (2.4K) 1/2W 5%TR resistors
  - one 2200 $\Omega$  (2.2K) 1/2W 5%TR resistor
  - one 1000 $\Omega$  (1K) 1/2W 5%TR resistor

## 2 Installation

The following sections provide a thorough description of how to wire and configure devices and zones.

### 2.1 Installation Steps

Read this section completely before you begin. Once you have an overall understanding of the installation process, carefully work through each step.

#### Step 1: Creating a Layout

Draw a rough sketch of the building to get an idea of where all alarm detection devices, keypads and other modules are to be located.

#### Step 2: Mounting the Panel

Begin the installation by mounting additional modules in the cabinet using the stand-offs provided. Then, mount the cabinet in a dry, protected area close to an unswitched AC power source and the incoming telephone line. Before attaching the cabinet to the wall, be sure to press the four circuit board mounting studs into the cabinet from the back. After you have attached the cabinet to the wall, stick the provided DSC logo sticker on the front of the cabinet.

**Note:** You must complete all wiring before connecting the battery, telephone wires and/or applying AC to the panel. Before these operations are performed, the cabinet shall be properly secured to the building structure.

**Note:** The metallic cabinet door shall be locked using a key (lock) and minimum 2 (two) screws.

#### Step 3: Wiring the Keybus (Section 2.4)

Wire the Keybus to each of the modules following the guidelines provided in Section 2.4 Keybus Operation and Wiring.

#### Step 4: Zone Wiring (Section 2.8)

You must power down the control panel to complete all zone wiring. Please refer to Section 2.9 Zone Wiring when connecting zones using normally closed loops, single EOL resistors, double EOL resistors, Fire zones and Keyswitch Arming zones.

#### Step 5: Complete Wiring (Section 2.2)

Complete all other wiring including bells or sirens, telephone line connections, and ground connections following the guidelines provided in Section 2.2 Terminal Descriptions.

#### Step 6: Powering up the Control Panel

Once all zone and Keybus wiring is complete, power up the control panel. First, connect the red battery lead to the positive terminal and the black lead to negative. Then, connect the AC.

**Note:** Connect the battery before connecting the AC. You must apply AC power to the panel for at least 10 seconds, or the panel will not function. The panel will not power up on the battery connection alone.

#### Step 7: Keypad Assignment (Section 2.6)

In order for keypads to be properly supervised, each must be assigned to a different slot. Please follow the guidelines provided in Section 2.5 Current Ratings – Modules & Accessories when assigning keypads.

#### Step 8: Supervision (Section 2.7)

The supervision of each module by the panel is automatically enabled upon power up. Please verify that all modules appear on the system according to the instructions in Section 2.6 Keypad Assignment.

#### Step 9: Programming the System (Sections 4 & 5)

Section 4 Programming explains how to program the panel. Fill out the Programming Worksheets completely before attempting to program the system. (See Section 5 Programming Worksheets).

#### Step 10: Testing the System

Test the panel thoroughly to ensure that all features and functions are operating as programmed.

### 2.2 Terminal Descriptions

#### Battery Connection

A 12V 4 Ah or 7Ah rechargeable battery is used as a backup source of power in the event of an AC power failure. A sealed, rechargeable, lead acid or gel type battery is required to meet UL requirements for power standby times.

**Note:** UL/ULC Residential Burglary installations require 4 Hrs power standby time plus 4 minutes alarm annunciation.

**Note:** UL/ULC Residential Fire installations require 24 Hrs power standby time plus 4 minutes (UL) or 5 minutes (ULC) alarm notification.

Standby Battery Guide		
Battery Charging Current: 350 mA		
Battery Size	Standby	
	4 Hr	24 Hr
4Ahr	550mA	--
7Ahr	550mA	180mA

**Note:** Connect the battery before connecting the AC.

Connect the RED battery lead to the positive battery terminal; connect the BLACK lead to negative.

**Note:** Battery capacity will deteriorate with age and number of charge/discharge cycles. Replace every 3-5 years.

#### AC Terminals

The panel requires a 16.5V<sub>AC</sub>, 40VA transformer. Connect the transformer to an unswitched AC source and connect the transformer to these terminals.

**Note:** Do not connect the transformer until all other wiring is complete. The transformer secondary wire distance is as shown below:

AWG	Feet	Metres
24	5.8	1.8
22	9.3	2.8
20	14.8	4.5
18	23.5	7.2

**Note:** For UL installations, use only wire size AWG 18, 20 or 22.

**Note:** For UL Listed installations, do NOT connect transformer to a receptacle controlled by a switch.

#### AUX+ and AUX- Auxiliary Power Terminals

These terminals provide up to 550mA of current at 11.1–12.5 V<sub>DC</sub> for modules, powered detectors, relays, and LEDs. If the total current required exceeds 550mA, an additional power supply is required (e.g., PC5200, PC5204). Refer to Table 1-1, Supported Modules for the current draw of individual devices. Connect the positive side of any device requiring power to the AUX+ terminal, the negative side to AUX- (ground). The AUX output is protected. This means that if too much current is drawn from these terminals (such as a wiring short), the panel will temporarily shut off the output until the problem is corrected.

#### Bell Output Terminals – BELL+ and BELL-

These terminals provide up to 700 mA of continuous current at 11.1-12.5 V<sub>DC</sub> for powering bells, sirens, strobes or other warning-type equipment (e.g. DSC SD-15 WULF). To comply with NFPA 72 Temporal Three Pattern requirements: Program Section [013] Option 8 ON.

**Note:** Steady, pulsed alarms and temporal four (CO) alarms are also supported.

Connect the positive side of any alarm warning device to BELL+, the negative side to BELL-. Please note that the Bell output is protected: if too much current is drawn from these terminals (such as a wiring short), the panel will shut down the output. Two amps can be drawn for short periods only.

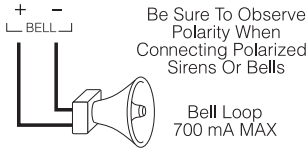

The Bell output is supervised and power limited by 2A PTC. If an alarm warning device is connected to the bell terminals, a termination resistor is not necessary. If no alarm warning devices are in use, connect a 1000Ω resistor

across BELL+ and BELL- to prevent a Bell Circuit Trouble from being generated. For more information, please refer to [\*][2]Trouble Display).

**Keybus Terminals – AUX+, AUX-, YEL, GRN**

The Keybus is used by the panel to communicate with modules and vice versa. Each module has four Keybus terminals that must be connected to the four Keybus terminals on the panel. For more information, see Section 2.4 Keybus Operation and Wiring.

**Programmable Output Terminals – PGM 1 and PGM 2**

Each PGM output is designed so that when activated by the panel, the terminal will switch to ground. PGM 1 can provide up to 50mA. Connect the positive side of the LED or buzzer to AUX+, the negative side to PGM 1. PGM 2 can provide up to 300mA current-limited switched programmable output. If more than 50 mA of current are required, a relay must be used. Please study PGM wiring in the accompanying diagram. Two-wire smoke detectors (90mA current limited) are supported using PGM 2. For a list, please see the section on Programmable Output Options.

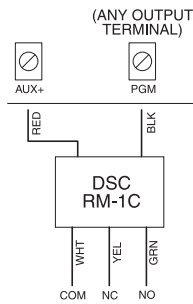

**Note:** For UL installations, use only UL-listed relays.

**Zone Input Terminals – Z1 to Z4**

Each detection device must be connected to a zone on the control panel. It is suggested that one detection device be connected to each zone; wiring multiple detection devices to a single zone, however, is possible. For zone wiring specifics, please see Section 2.9 Zone Wiring.

**Telephone Line Wiring**

Wire the telephone connection terminals (TIP, Ring, T-1, R-1) to an RJ-31x Connector as indicated. For connection of multiple devices to the telephone line, wire in the sequence indicated. Use 26 AWG wire minimum for wiring.

Telephone format is programmed in option [350]. Telephone Call Directions are programmed in options [351]-[376].

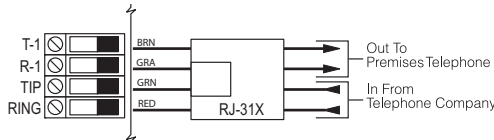

Please ensure that all plugs and jacks meet the dimension, tolerance and metallic plating requirements of 47 C.F.R. Part 68, SubPart F. For proper operation, no other telephone equipment should be connected between the control panel and the telephone company facilities. Do not connect the alarm panel communicator to telephone lines intended for use with a fax machine. These lines may incorporate a voice filter which disconnects the line if anything other than fax signals are detected, resulting in incomplete transmissions.

**Ground Connection**

Using an insulated green wire of minimum 22AWG, connect the EGND terminal from the PCB assembly to the GND Point on the control panel's cabinet. The GND Point could be any available hole on the back or on the side of the metal cabinet where the grounding wire from the EGND terminal on the PCB assembly and the grounding wire from the building electrical installation could be attached together as indicated in the wiring diagram on page v or on the wiring diagram attached to the cabinet.

**Note:** Wire and installation hardware not included.

**2.3 Wire Routing for Power & Non-Power Limited**

All wiring entry points are designated by the arrows. All circuits are classified UL installation power limited except for the battery leads which are not power limited. A minimum 1/4" (7mm) separation must be maintained at all points between power limited and non-power limited wiring and connections.

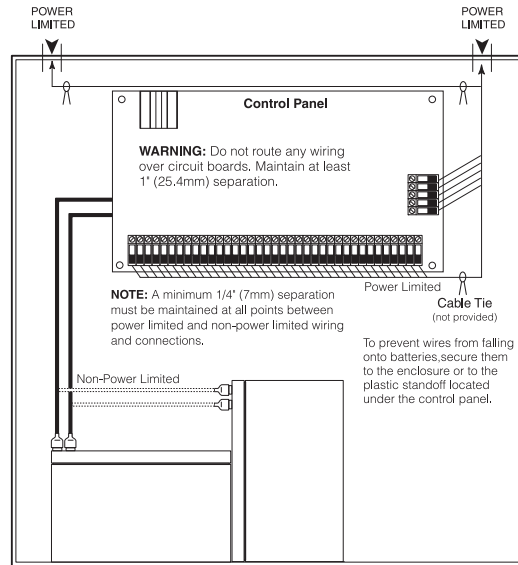

**Note:** Wire entry for power limited wiring must be separated by using a different entry access from non-power limited wiring.

**2.4 Keybus Operation and Wiring**

The Keybus is used by the panel to communicate with all connected modules and vice versa. The red (AUX+) and black (AUX-) terminals are used to provide power, while the yellow (YEL) and green (GRN) terminals are clock and data respectively.

**Note:** The four Keybus terminals of the panel must be connected to the four Keybus terminals or wires of all modules.

The following restrictions apply to Keybus wiring:

- Keybus should be run in minimum 22 AWG quad (0.5mm), maximum 18 AWG; two pair twist is preferred.
- The modules can be home-run to the panel, connected in series or T-tapped, provided that the maximum wire distance from the control panel to any module does not exceed 1,000' (305m).
- Any module can be connected anywhere along the Keybus. You do not need to run a separate Keybus wire for keypads etc.

**Note:** Depending on a module's current draw, there may be additional limitations of the wire run length of power and ground.

- Shielded wire should not be used.

### Example of Keybus Wiring

**Note:** Module (A) is correctly wired within 1,000'/305m of wire from the panel.

Module (B) is correctly wired within 1,000'/305m of wire from the panel. Module (C) is NOT wired correctly as it is further than 1,000'/305m from the panel, in wire distance.

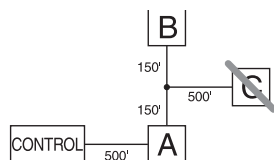

## 2.5 Current Ratings – Modules & Accessories

In order for the PC1404 system to operate properly, the power output capabilities of the main control and the expansion devices must not be exceeded. Use the data presented below to ensure that no part of the system is overloaded, affecting its function.

### PC1404 (12 Vdc)

AUX+: 550mA: Subtract the listed rating for each keypad, expansion module and accessory connected to AUX+ or Keybus.

BELL: 700mA Supervised (1k Ohm) Bell Output (Current Limited at 2A).

**Note:** AUX and PGM outputs share the 550mA load.

### PC1404 Device Ratings (at 12 Vdc)

- PC1404RKZ keypad: 120mA
- PK55XX keypad: 125mA
- PC1555RKZ keypad: 85mA
- PC5601 LED status module: 30mA
- LCD5511 keypad: 85mA
- LED5511Z keypad: 100mA
- PC5200 power supply: 20 mA
- PC5204 power supply with 4 PGMs: 20 mA
- PC5208 low current PGM module: 20 mA
- TL300 communicator: 360mA
- GS3060 communicator: 120mA
- 3G3070 communicator: 120mA
- GS3105/3125-K & BA communicator: 250mA

### Other Devices

Please read the manufacturer's literature carefully to determine the maximum current requirements for each device—during activation or alarm—and include the proper values for loading calculations. Connected devices must not exceed system capabilities during any possible operational mode.

## 2.6 Keypad Assignment

Once the wiring is complete and the keypad is fixed on the wall, a 2-digit number must be entered to tell the system the partition and slot assignment of the keypad. At each keypad installed on the system

1. Enter Installer Programming by pressing [\*][8][Installer Code].
2. Press [000] for keypad programming.
3. Press [0] for Partition and Slot Assignment.
4. Enter a 2-digit number to specify the partition and slot assignment as follows:
  - a) As the PC1404 does not have partitions, enter [1] for the first digit. If the first digit is incorrectly programmed with a value greater than 1, the keypad will not respond when connected to a single partition system (e.g. PC1404). Press and hold the 1 key on the keypad, then re-enter section [000][0] to correct the programming.
  - b) Assign each keypad to its own slot (1 to 8). LED keypads, the LCD5511 and the PC1404RKZ keypads are always assigned to slot 1 by default. PK5500 keypads are always assigned to slot 8. Keypad assignment is required, as it tells the panel which slots are occupied. The panel can then generate a keypad supervision trouble when the keypad is detected as missing.

**Note:** One LCD keypad must be assigned to slot 8 in order to upload keypad programming using DLS software.

- c) Press the [#] key twice to exit programming.
- d) After assigning all keypads, perform a supervisory reset by entering [\*][8][Installer Code][902]. The panel will reset supervision and re-enroll modules on the system.

## How to Program Function Keys

By default, the 5 function keys on each keypad are programmed as Stay Arm (03), Away Arm (04), Chime (06), Sensor Reset (14) and Quick Exit (16). You can change the function of each key on every keypad:

1. Go to the keypad where you want to change the function key programming and enter Installer Programming.
2. Press [000] for Keypad Programming.
3. Enter [1] to [5] to select a function key to program.
4. Enter the 2-digit number [00] to [32] to select the feature you want the function key to have. For a complete list, see Function Key Options on page 19.
5. Continue from step 3 until all function keys are programmed.
6. To exit Installer Programming, press [#] twice.

## 2.7 Supervision

By default, all modules are supervised upon installation. Supervision is enabled at all times so that the panel can indicate a trouble if a module is removed from the system.

To check which modules are currently connected and supervised, enter programming Section [903] from Installer Programming. An LCD keypad will allow you to scroll through the display of connected modules. A connected module which does not show as being present will appear as a trouble condition and the Trouble light on the keypad will turn ON. This condition may be due to one or more of the following reasons:

- the module is not connected to the Keybus
- there is a Keybus wiring problem
- the module is more than 1,000'/305m from the panel
- the module does not have enough power

For more information regarding module supervision troubles, please refer to [\*][2]Trouble Display.

## 2.8 Removing Modules

The panel must be instructed to no longer supervise a module being removed from the system. To remove the module, disconnect it from the Keybus and reset the supervision field by entering [902] in Installer Programming. The panel will reset supervision of all existing modules attached to the keybus.

## 2.9 Zone Wiring

For a complete description of the operation of all zone types, please refer to [001] Zone Definitions.

There are several different ways in which zones may be wired, depending on which programming options have been selected. The panel can be programmed to supervise normally closed, End of Line, Double End of Line, or zone doubling loops. Please refer to the following diagrams to study each type of individually supervised zone wiring.

**Note:** Any zone programmed for Fire, 24-hr Supervisory, or CO must be wired with a single End of Line (SEOL) resistor regardless of the type of zone wiring supervision selected for the panel ([013] First System Options: [1]-[2]).

**Note:** If you change the zone supervision options from DEOL to SEOL or from NC to DEOL (See [013] First System Options, Options [1] or [2]), you should power down the system completely, and then power it back up. If you do not, the zones may not work correctly.

### Normally Closed (NC) Loops

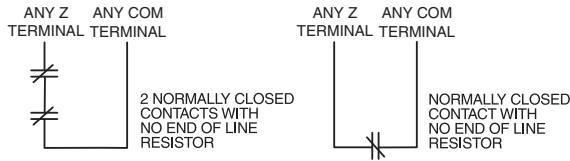

To enable normally closed loops, Section [013], Option [1] must be ON.

**Note:** This option should only be selected if Normally Closed (NC) detection devices or contacts are being used.

### Single End Of Line (EOL) Resistors (5600Ω)

To enable panel detection of single end of line resistors, Section [013], Options [1] and [2] must be OFF.

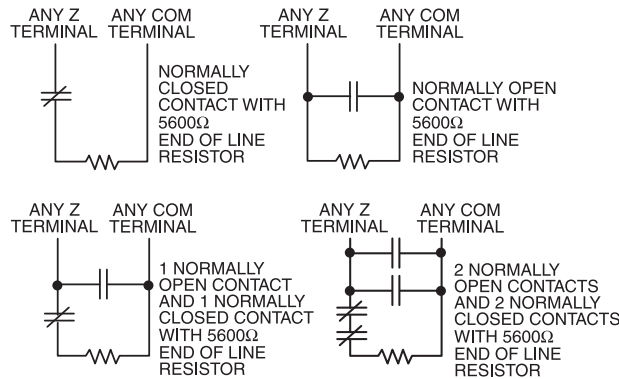

**Note:** This option should be selected if either Normally Closed (NC) or Normally Open (NO) detection devices or contacts are being used.

### Double End of Line (DEOL) Resistors

Double End of Line resistors allow the panel to determine if the zone is in alarm, tampered or faulted.

To enable panel detection of double end of line resistors, Section [013], Option [1] must be OFF and Option [2] must be ON.

**Note:** If the Double EOL supervision option is enabled, all hard-wire zones on the main panel must be wired for Double EOL resistors, except for Fire, CO and 24-hr Supervisory zones.

**Note:** Do not use DEOL resistors for Fire zones, CO zones or 24-hr Supervisory zones. Do not wire Fire zones to keypad zone terminals if the DEOL supervision option is selected.

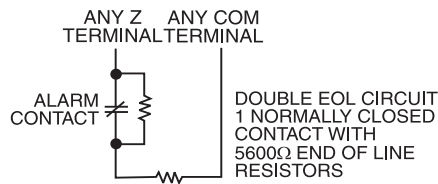

**Note:** This option can only be selected if Normally Closed (NC) detection devices or contacts are being used.

The following chart shows zone status under certain conditions:

Loop Resistance	Loop Status
0Ω (shorted wire, loop shorted)	Fault
5600Ω (contact closed)	Secure
Infinite (broken wire, loop open)	Tamper
11200Ω (contact open)	Violated

End of Line Resistors ..... Section [013]: [1]  
 Double End of Line Resistors ..... Section [013]: [2]

## 2.10 Zone Doubling

Zone Doubling is a feature that will allow you to double the zones on the main board from 4 to 8. To enable zone doubling, Section 13 Option [7] must be ON. All zones must be wired according to the following diagram. Only Normally Closed devices can be used with zone doubling.

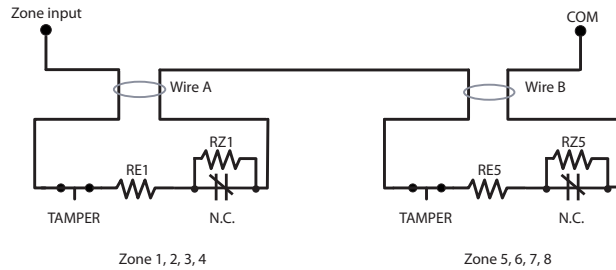

<b>RE1</b>	<b>RZ1</b>	<b>RE5</b>	<b>RZ5</b>
1500	5600	1500	2400

**Note:** All resistors are 5% tolerance.

The loop using the 1500Ω and 5600Ω resistors is the first zone (Zone 1, 2, 3, or 4). The loop using the 1500Ω and 2400Ω resistors is the second zone (Zone 5, 6, 7, or 8). For example, loop 1 is Zone 1 and loop 2 is Zone 5. The following table shows zone status under certain conditions:

Nominal	Tamper	Zone 1	Zone 5	Fault
∞	✓	–	–	–
11000	–	open	open	–
8600	–	open	restore	–
7100	–	–	–	✓
5400	–	restore	open	–
3900	–	–	–	✓
3000	–	restore	restore	–
1500	–	–	–	✓

**Note:** The following will be seen by the installer if the end-of-line resistors have not been installed correctly, when both zones are physically closed:

Zone 1 open, Zone 5 restored	This may be caused by RE1 and RZ1 as well as RE5 and RZ5 being switched.
Both zones showing as faulted.	This may be caused by RE1 and RZ1, or RE5 and RZ5, being switched.

**Note:** If zone doubling is enabled, fire zones should not be programmed. 2-wire smoke loops can still be used.

**Note:** If zone doubling is enabled, keypad zones should not be programmed.

**Note:** If fire zone types are programmed in Section [001], or if a keypad zone has been assigned, it will not be possible to enable the zone doubling option in Section [013].

## 2.11 Fire Zone Wiring

All 4-wire smoke detectors must be wired according to the following diagram:

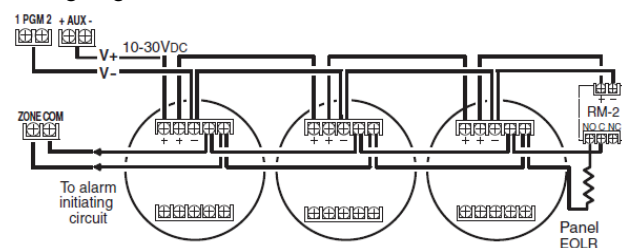

All 2-wire smoke detectors must be wired according to the following diagram:

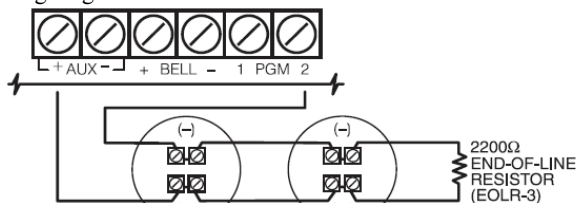

Additional 2-wire smoke detectors must be connected in parallel as shown above.

### 2-wire smoke detector initiating circuit:

- Style B (Class B), Supervised, Power Limited
- UL Compatibility Identifier . . . . . PC14-1
- DC Output Voltage . . . . . 9.3-13.7 VDC
- Detector Load . . . . . 2mA (Max.)
- Single-end-of-line (SEOL) resistor . . . . . 2200Ω
- Loop resistance . . . . . 24Ω (Max.)
- Standby impedance . . . . . 1250Ω (Nom.)
- Alarm impedance . . . . . 650Ω (Max.)
- Alarm current . . . . . 94mA (Max.)

## 2.12 CO Detector Wiring

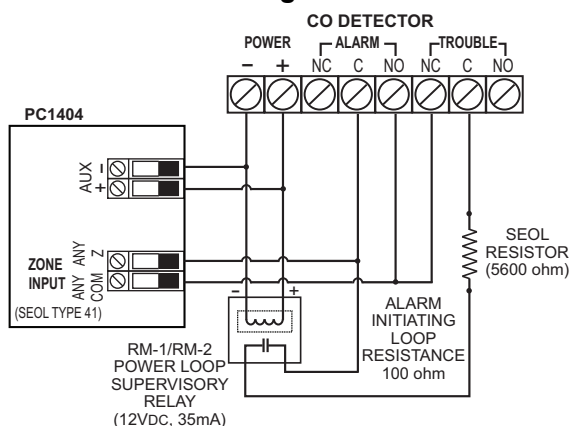

The following CO detector models can be used with PC1404 v1.0 and higher control panels:

- Potter Model CO-12/24, UL File E321434
- Quantum Model 12-24SIR, UL File E186246
- NAPCO Model FW-CO12 or FW-CO1224, UL File E306780
- System Sensor Model CO1224, UL File E307195

## 2.13 Keypad Zones

Each “z” keypad on the system has a zone input to which a device – such as a door contact – can be connected. This eliminates the need to run wires back to the control panel for every device.

To install the keypad, open the keypad plastic at the bottom of the unit. Locate the five terminals on the keypad circuit board. Connect the four Keybus wires from the control panel: the red wire to R, the black to B, the yellow to Y and the green to G.

To connect the zone, run one wire to the Z terminal and the other to B. For powered devices, use red and black to supply power to the device. Run the red wire to the R (positive) terminal and the black wire to the B (negative) terminal.

When using end of line supervision, connect the zone according to one of the configurations outlined in Section 2.9 Zone Wiring. End of line resistors must be placed on the device end of the loop, not at the keypad.

Keypad circuit board



Keypads without zone support do not have this "Z" terminal

**Note:** Only non 24-hr burglary zones can be configured as keypad zones for UL Listed products.

### Assigning Keypad Zones

When using keypad zone inputs, each input used must be assigned a zone number in Installer Programming.

1. Ensure that you have enrolled all installed keypads into the desired slots. (See Section 2.6 Keypad Assignment.)
2. Enter [\*][8] [Installer Code] to go to Installer Programming.
3. Enter Section [20] for Keypad Programming. There are eight programming locations in this section, one for each keypad slot.
4. Enter a 2-digit number (01-08) to specify which zone number should be assigned to the keypad slot. This number must be entered in the location corresponding to the keypad to which each zone is connected.
5. Press [#] twice to exit Installer Programming.

**Example:** The zone on an PK5500 keypad in Slot 8 is to be assigned Zone 3. In Section [020], scroll to Option [8] and enter (03).

**Note:** Keypad Zones 1-4 will replace Zone terminals Z1-Z4 on the control panel.

**Note:** Once the keypad zones are assigned, you must also program zone definitions and zone attributes. (See also 5.2 Programming Worksheets).

**Note:** Keypad zones can only be used for household burglary-initiated devices. Do not place the device more than 3 feet from the keypad. The keypad zone must be tested weekly.

## 2.14 PC1404RKZ Installation Instructions

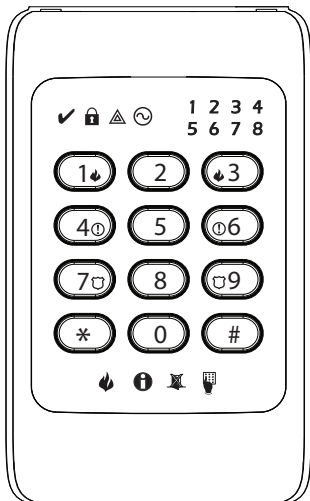

The PC1404RKZ is compatible with the PC1404 security system. These instructions shall be used in conjunction with the Installation Manual of the PC1404 alarm controller.

The PC1404RKZ keypad presents system status using LEDs along with symbols and numbers. The keypad can be used on security systems with up to 8 zones.

### Specifications

- Supply voltage: 7VDC-14.5VDC
- Compatible control panel keybus connection provided by DSC
- Connects to control panel via 4-wire keybus
- One keypad zone input
- Current draw: 120mA (maximum)
- Optional tamper version
- Four programmable function keys
- Ready (green), Armed (red), and Trouble (amber) status lights

**Note:** This keypad is available to order with white (WH) or yellow (YEL) LED backlightings.

### Unpacking

The PC1404RKZ package includes the following parts:

- one PC1404RKZ keypad
- one tamper switch
- three mounting screws
- one set of Installation Instructions
- three anchors for wall-mounting screws
- keypad inner door labels
- one end-of-line resistor

### Mounting

Mount the keypad where it is accessible to designated points of entry and exit. Once a dry and secure location is selected, perform the following steps to mount the keypad:

1. Remove the keypad frontplate by inserting a screwdriver into the slots located on the top of the keypad.
2. Secure the keypad backplate to the wall in the desired location. Use all the screws provided. Use the plastic anchors supplied if the unit is to be mounted on drywall.
3. To use the keypad tamper, insert the supplied tamper switch into the opening located in the centre of the backplate, and secure the tamper to the wall with a screw.
4. For tamper use, the backplate should be mounted on a smooth, flat surface. If mounting on a rough surface, fasten the enclosed surface tape to the wall to even out the surface area where the tamper will be positioned.
5. Before attaching the keypad to its backplate, complete the keypad wiring as described in the next section.

### Wiring

1. Before wiring the unit, ensure that all power (AC transformer and battery) is disconnected from the control panel.
2. Connect the four Keybus wires from the control panel (red, black, yellow and green) to the keypad terminals (RED, BLK, YEL, GRN). Consult the diagram below:
3. Connect a device, such as a door contact, to the 'Z' terminal of the PC1404RKZ. This eliminates the need to run wires back to the control panel for the device. To connect the zone, run one wire from the device to the 'Z' terminal and the other wire from the device to the BLK (black) terminal. For powered devices, run the red wire to the RED (positive) terminal and the black wire to the BLK (negative) terminal. When using end of line supervision, connect the zone according to one of the configurations outlined in your system's Installation Manual.

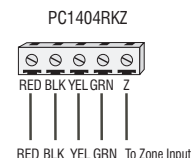

### Applying Power

Once all wiring is complete, apply power to the control panel:

1. Connect the battery leads to the battery.
2. Connect the AC transformer.

For more information on control panel power specifications, see the control panel Installation Manual.

**Note:** Do not connect the power until all wiring is complete.

### Enrolling the Keypad

See 2.6 Keypad Assignment to enroll the keypad.

### Power Save Mode

If power save mode is enabled and AC power fails, all keypad lights, including backlighting, shut off. The keypad lights will come back ON after a keypress, entry delay, audible alarm or keypad buzzer condition (except door chime). The keypad lights will return to the off state after 30 seconds of no activity. If the AC fail condition is restored, the keypad lights will be reactivated.

### Keypad Icons

Ready Status		The green ready status icon is on when the system is ready to arm.
Armed Status		The red armed status icon is on when the system has been successfully armed.
Trouble Status		The trouble status icon is lit when there is a trouble present on the system. To see if a trouble is present press [*][2]. If any number is lit, a trouble condition is present. Refer to your system manual to identify what trouble condition is present.
AC Status		The green AC status icon can be configured to indicate presence or absence of AC; see AC LED Options and Keypad Toggle Options sections [5] and [6].
Fire Memory		The red fire memory icon is lit when a fire alarm is in progress or has occurred. If zone 4, as an example, is programmed as a fire zone and goes into alarm, the keypad will turn on the zone 4 LED and the fire icon to indicate a fire alarm is present on zone 4.
Alarm Memory		The alarm memory icon is lit when there is a zone in alarm memory. To see if there is a zone in alarm memory press [*][3]. If any number is lit, the corresponding zone is in alarm memory. Refer to your system manual for further information.
Bypass		The bypass icon is lit when a zone is bypassed on the system. To see if a zone is bypassed press [*][1]. If any number is lit, the corresponding zone is bypassed. Refer to your system manual for information on bypassing and removing a bypass.
Programming		The programming icon indicates when the keypad is in Installer Programming. This LED also activates when the keypad is busy.

### Changing the Buzzer Level

The user can change the keypad buzzer frequency by pressing and holding the [\*] key. After the key has been pressed for 2 seconds, the keypad changes the frequency and beeps so the user

can hear the new tone. If the key is held down, every second the keypad will increment the frequency and sound another tone. There are 21 levels. Once the desired level is reached, press [\*] to exit.

### Programming the Function Keys

The function keys are programmed in sections [000][1-4]. By default, the 4 function keys on the keypad are programmed as Stay Arm (03), Away Arm (04), Chime (06), and Sensor Reset (14). Activate the function keys as follows:

Function key 1 - Press and hold the #2 key for 2 seconds

Function key 2 - Press and hold the #5 key for 2 seconds

Function key 3 - Press and hold the #8 key for 2 seconds

Function key 4 - Press and hold the #0 key for 2 seconds

See Keypad Function Keys below for the other function key options available for your system.

### Emergency Key Options (Fire, Auxiliary, Panic)

You can enable or disable the Fire, Auxiliary and Panic keys at each keypad. These keys are enabled by default. To turn any of the emergency keys on or off on the keypad:

- Enter [\*][8][Installer Code].
- Enter [000] to go to keypad programming.
- Enter section [6].
- To turn the emergency key options on or off, press [1], [2], or [3]:
  - [1] ON=Fire key enabled      OFF=Fire key disabled
  - [2] ON=Auxiliary key enabled OFF=Auxiliary key disabled
  - [3] ON=Panic key enabled    OFF=Panic key disabled
- When complete, press [#] to exit.

### Activating Emergency Keys

- **Fire Key**  
To activate a fire alarm, press and hold keys #1 and #3 simultaneously for 2 seconds.
- **Auxiliary Key**  
To activate an auxiliary alarm, press and hold keys #4 and #6 simultaneously for 2 seconds.
- **Police Key**  
To activate a police alarm, press and hold keys #7 & #9 simultaneously for 2 seconds.

### Night Light Feature (available in PC1404RKZWH order code)

White LEDs are on the left and right side of the keypad to make the keypad easier to locate in the dark. To turn the night lights on or off:

- Enter [\*][8][Installer Code].
- Enter [000] to go to keypad programming.
- Enter Keypad Toggle Options section [6].
- Turn option 4 on or off to enable or disable the night light feature.
- When complete, press [#] to exit.

### AC LED Options

The AC LED can be enabled or disabled, and can be configured to indicate if AC is present or absent. To turn the AC LED on or off:

- Enter [\*][8][Installer Code].
- Enter [000] to go to keypad programming.
- Enter Keypad Toggle Options section [6].
- To turn the AC LED feature on or off, press 5.
- To control whether the LED indicates AC present or absent, press 6.
- When complete, press [#] to exit.

### Backlighting Intensity Adjustment

The keypad has 5 backlighting intensity settings. To adjust the backlighting intensity:

- Enter [\*][8][Installer Code].
- Enter [000] to go to keypad programming.

- To adjust the intensity of the backlighting LEDs, repeatedly press [9].
- When complete, press [#] to exit.

### Programming worksheet

#### [000] Keypad Programming

- Enter [\*][8][Installer Code].
- Enter [000] to go to keypad programming.

#### [0] Keypad Enrollment

Valid entries are 01-18; e.g., enter [11] for partition 1, slot 1.  
1st digit: Enter 0 to 8 for partition assignment (0 = Global Keypad).  
2nd digit: Enter 1 to 8 for slot assignment

Default: 11 | | | |

#### [1]-[4] Function Key Assignments

	[1] Key 1	[2] Key 2	[3] Key 3	[4] Key 4
Defaults	03	04	06	14
	Stay	Away	Chime	Sensor Reset

| | | | | | | |

#### Keypad Function Keys

[00] - Null key (key not used)	[13] - Command output 1 (*71)
[01]-[02] - Not used	[14] - Command output 2 (*72)/ Sensor reset
[03] - Stay arm	[15] - Not used
[04] - Away arm	[16] - [*][0] Quick exit
[05] - [*][9] No entry arm	[17] - [*][1] Activate stay/away
[06] - [*][4] Chime On/Off	[18] - Not used
[07] - Not used	[19] - Command output 3 (*73)
[08] - [*][1] Bypass mode	[20] - Night arming
[09] - [*][2] Trouble display	[21] - Command output 4 (*74)
[10] - Not used	[22]-[24] Not used
[11] - [*][5] User code programming	[25] - Instant stay arm
[12] - [*][6] User functions	[26]-[32] - Not used

#### [6] Keypad Toggle Options

Option	
1	[F] key enabled/disabled
2	[A] key enabled/disabled
3	[P] key enabled/disabled
4	Night light enabled/disabled: When enabled, the white LEDs on each side of the keypad are activated. When disabled, the white LEDs on each side of the keypad are deactivated.
5	AC LED enabled/disabled: When enabled, the keypad's AC LED indicates either the presence or absence of AC power to the control panel, depending on the programming of option 6 in section [000][6]. When disabled, the keypad's AC LED remains off in all conditions.
6	AC LED on when AC present/AC LED on when AC absent: This toggle option requires option 5 in section [000][6], AC LED enabled/disabled, to be enabled. When this option is on, the keypad's AC LED turns on to indicate that the control panel has AC power, and turns off to indicate that AC power has been lost. When this option is off, the keypad's AC LED turns on to indicate that AC power has been lost, and turns off to indicate that the control panel has AC power.
7-8	Not used



### 3 Keypad Commands

Use any compatible keypad to enter commands and/or program the PC1404 security system. The LED keypad uses function and zone indicator lights to represent alarm functions and status. The LCD keypad provides a written description on the liquid crystal display and uses function indicator lights to communicate alarm status to the user.

The PC1404 User Manual provides basic directions for arming and disarming the system, bypassing zones and performing user functions from the keypads. The following sections provide additional details on these functions.

#### 3.1 Arming and Disarming

For a description of basic arming and disarming, please see the PC1404 User Manual. For other methods of arming, please refer to [\*][0] – Quick Arm and [\*][9][User Code] – No-Entry Arming.

The event buffer will log “armed in stay mode,” “armed in away mode,” or “armed in night mode” whenever the system is armed.

The arming procedure initiated by pressing Away function key on keypad is the same as the arming procedure initiated by entering user codes. For CP-01 systems, if there is no exit event (delay 1 zone violated and restored) prior to the exit delay expiring, the system will be armed in Stay mode.

In an attempt to prevent false alarms, the **Audible Exit Fault** will notify the user of an improper exit when they arm their system. If a non force-arming Delay 1 or Delay 2 type zone is left open at the end of the exit delay, the entry delay will begin immediately and the bell or siren will sound a steady alarm for the entry delay period. At the end of the entry delay period, if the system has not been disarmed it will go into alarm. This feature can be turned OFF in Section [013], Option [6].

#### 3.2 Auto Bypass – Stay Arming

Stay arming allows the user to arm the system without leaving the premises. All zones programmed as stay/away will be bypassed when the user stay arms the system, so that the user does not have to bypass interior zones manually. (See “Zone Programming” in PC1404 Programming Descriptions. For these descriptions, see the Technical Library section of <http://www.dsc.com>.)

When the system is armed using a valid access code, if any zones on the system have been programmed as stay/away zones, the Bypass light will turn ON. The panel will then monitor all zones programmed as Delay 1 and Delay 2 zones, such as designated entry/exit doors. If a delay zone is not violated by the end of the exit delay, the panel will bypass all stay/away zones. The Bypass light will remain on to inform the user that the interior zones have been automatically bypassed by the panel. If a delay zone is violated during the exit delay, the system will arm in Away mode and all stay/away zones will be active after the exit delay expires.

The user can arm the stay/away zones at any time by entering the [\*][1] keypad command. (See “[\*][1] Bypassing and Activating Stay/Away and Night Zones”.)

Stay arming can also be initiated by pressing and holding the Stay function key for two seconds on the supported keypads, if programmed by the installer. For more information regarding Stay arming, see [000] in Keypad Function Programming in PC1404 Programming Descriptions.

#### 3.3 Automatic Arming

The system can be programmed to arm at the same time each day. Upon entry of this section, enter 4 digits for the 24 Hour Auto-Arm time. At the selected Auto-Arm time, the keypad buzzers will sound for the time programmed in Section [199] to warn that an Auto-Arm is in progress. The bell can also be programmed to squawk once every 10 seconds during this warning period. When the warning period is complete, the system will arm with no exit delay and in the Away Mode. Note: For CP-01 systems, the system will arm with an exit delay. If no Delay 1 zone violation and restore occurs during this exit delay, the system will arm in Away mode. If a Delay 1 zone is left violated when the exit delay ends, an audible exit fault will occur if the feature is enabled. The exit delay restart feature applies to this entry delay (see Section [18] Option 7.)

Auto-Arming can be cancelled or postponed only by entering a valid access code during the programmed warning period. When the code has been entered, the warning will be silenced and Auto-Arming will be cancelled or postponed, depending on the programming of Section [175]. Auto-Arming will be attempted at the same time the next day. Whenever the Auto-Arming process is canceled or postponed, the Auto-Arm Cancellation Reporting Code will be transmitted (if programmed).

If arming is inhibited by one of the following, the Auto-Arm Cancellation transmission will be communicated.

- AC / DC Inhibit Arm
- Latching System Tamper
- Zone Expander Supervisory Fault

**Note:** PC1404 only supports one entry of Auto-Arm Time programming, so the programmed time shall be used for every day.

#### 3.4 Night Arming

Night arming is intended to arm the perimeter and restrict movement to designated areas in the interior (e.g., hallways from bedrooms to bathrooms).

If night zones are programmed, entering [\*][1] while the system is armed in stay mode will activate all interior zones except those programmed as night zones. The panel can also be armed in Night mode by pressing the Night Arm function key for 2 seconds while the system is disarmed. The Ready light must be on (disarmed) or the system must be armed in Stay mode to Night arm the system. In Night mode only night zones (Zone definition 37) are bypassed. When activated, no acknowledgement beeps are sounded, the exit delay is silent and the panel logs “Armed in Night Mode.” If no night zone types are programmed, the system arms in Away mode and the panel logs “Armed in Away Mode.”

#### 3.5 [\*] Commands

The [\*] key commands provide an easy way for the user to access basic system programming – such as programming access codes or bypassing zones. The user can also use the [\*] key commands to check on the system’s status, including viewing trouble conditions and displaying the event buffer on the LCD keypad.

The [\*] key commands can be performed from both LCD and LED keypads. The LED keypad uses the zone indicator lights to display command information. The LCD display provides written information, guiding the user through each command. The commands in this section are explained as viewed from an LED keypad. When using an LCD keypad, use the arrow keys (< >) to scroll through information provided. Otherwise, the functions remain the same for both keypad types.

**[\*] Commands**

The following is a list of the [\*] commands available and a description of each:

[*][1]	Bypass (disarmed state)/Reactivate Stay/Away and Night Zones (armed state)
[*][2]	Display Trouble Conditions
[*][3]	Display Alarm Memory
[*][4]	Door Chime Enable/Disable
[*][5][Master/Supervisory Code]	User Code Programming
[*][6][Master/Supervisory Code]	User Functions
[*][7][x]	Command Functions 1–4
[*][8][Installer Code]	Installer Programming
[*][9][User Code]	No-Entry Arming
[*][0]	Quick Arm (disarmed state)/Quick Exit (armed state)

**[\*][1] Bypassing and Activating Stay/Away and Night Zones****LED Keypad**

Press [\*][1] to enter the bypass mode. If the Code Required for the Bypass option is enabled, enter a valid user code. The Bypass light will flash. The keypad will turn ON the corresponding zone light to indicate a zone is bypassed. To bypass or unbypass a zone, enter the 2-digit zone number. Once the correct zones are bypassed, press [#] to exit. The Bypass light will be ON if any zones are manually bypassed.

**LCD Keypad**

Press [\*][1] to enter the bypass mode. If the Code Required for the Bypass option is enabled, enter a valid user code. The keypad will display ‘Scroll to View Zones’. The keypad will display the programmed zone labels for the zones and include the letter ‘O’ in the bottom right corner if the zone is violated, or the letter ‘B’ if the zone is bypassed. Scroll to the appropriate zone and press the [\*] key to change the bypass status (or enter the 2-digit zone number). Once the correct zones are bypassed, press [#] to exit.

**Additional Bypass Commands:**

- Bypass Recall:** Press [99]. The keypad will recall the last group of zones that were bypassed.
- Clear Bypass:** Press [00]. The keypad will clear the bypass on all zones.
- Save Bypass:** Press [95]. The keypad will save which zones are manually bypassed.
- Recall Save:** Press [91]. The keypad will recall the bypassed zones that were saved.

<b>i</b>	<b>Hold-up Zones cannot be assigned to bypass groups.</b>
----------	---

**[\*][1] Activate Auto-Bypassed Stay/Away and Night Zones**

When the system is armed in the Stay mode by (a) arming and not exiting through a delay zone during the exit delay; or (b) pressing a function key programmed for Stay Arm or Arming Without Entry Delay [\*][9], the zones programmed as “Stay/Away” or “Night” type zones are automatically bypassed. This [\*][1] command is used to remove the automatic bypass from the Stay/Away zones to fully arm the system zones to fully or “Night” arm the system. Once this command is executed, all Stay/Away type zones will become active after the programmed Exit Delay time, making the system armed in Night or Away mode. When the system is armed in the Away or Night mode, if enabled by the installer, this [\*][1] command will bypass all of the “Stay/Away” type zones immediately, making the system armed in Stay mode. Night or Away mode is determined by whether there is a Night zone programmed on the system.

**Note:** Although there is an exit delay timer running, it is only an arming delay for the Stay/Away zones, and not a true exit delay where all non-24 hour zone types can be opened and closed for the purpose of exiting. Any zone type that is not a Stay/Away zone type will start its alarm sequence if violated during this “exit delay”. Users should press \*0 next to start a Quick Exit Delay to exit the premises.

**[\*][2] Trouble Display**

The panel continuously monitors a number of possible trouble conditions. If one of these conditions occurs, the keypad “Trouble” indicator will light and the audible indication will sound, two short beeps every 10 seconds (except AC failure). When the [#] key is pressed the audible indication will stop but the trouble is not cleared. Trouble conditions are logged to the Event Buffer and most troubles can also be transmitted to the monitoring station.

To view troubles, press [\*] then [2]. The “Zone” lights or LCD text display the trouble conditions 1-8.

Troubles 1, 5, and 6 can be expanded for more details by pressing the corresponding [1], [5], or [6] key.

Press [#] to return to the “Ready” mode. There is no Trouble memory. The Event Buffer can be used to achieve this function.

Viewing of troubles is now permitted while armed. The various troubles are described below:

Light	Trouble
1	<p><b>Service Required:</b> Press [1] to determine the specific trouble. Lights 1–8 will light up to indicate the trouble.</p> <p>Light [1] Low Battery: The standby battery's voltage is measured under load every 3 minutes and during a System Test. The limits of alarms and restores are determined by the Swinger Shutdown (Maintenance Troubles &amp; Restores) counter. Set at 3 by default, there will be 3 Low Battery Troubles and 3 Low Battery Restores before latching. The latching is reset at midnight or upon arming.</p> <p>Light [2] Bell Circuit Trouble: If the bell circuit is overdrawn or the bell circuit is open, a keypad trouble is generated and a Bell Circuit Trouble can be reported.</p> <p>Light [3] General System Trouble: Any peripheral module trouble will be indicated and communicated with a General Trouble, but logged to the event buffer with a detailed description.</p> <p>Light [4] General System Tamper: Any peripheral module tamper will be indicated and communicated with a General Tamper but logged to the event buffer with a detailed description.</p> <p>Light [5] General System Supervisory: If the system loses Supervisory signals from a peripheral module, this will be indicated and communicated with a General Supervisory but logged to the event buffer with a detailed description.</p> <p>Light [6] Not used.</p> <p>Light [7] PC5204 Low Battery: The PC5204 Module has detected a Low Battery Condition.</p> <p>Light [8] PC5204 AC Fail: The PC5204 Module has detected an AC Power Failure. This Trouble will initiate the keypad trouble beeps after the AC fail transmission delay if Trouble #2 is NOT present.</p>
2	<p><b>AC Failure:</b> There is no audible annunciation on AC power failure unless trouble beeps on AC failure are enabled in Section [018] Option [8]. The system "Trouble" light will come ON but the audible indication will not sound until there is a low battery condition. Transmission delay can be programmed for 000 to 255 minutes/hours. If the AC Fails, the battery will be continuously checked until the panel shuts down.</p>
3	<p><b>Telephone Line Monitoring Trouble (TLM):</b> The telephone line voltage is measured every 3 seconds. If the voltage drops below 1 to 3 volts for the number of consecutive checks programmed in Section [377], a Telephone Line Trouble is generated. This additional check denomination may fluctuate from board to board, as it is dependant on hardware component tolerances. The TLM Restore shall occur when the value in Section [377] is reached.</p>
4	<p><b>Failure to Communicate (FTC):</b> If the digital communicator is unsuccessful in communicating with any of the programmed telephone numbers, a failure to communicate trouble will be generated. If a later attempt to communicate is successful, the panel can also transmit the FTC restore reporting code and all previous unsuccessful events. If the digital communicator is unsuccessful in communicating with any of the programmed telephone numbers, a failure to communicate trouble will be generated. If a later attempt to communicate is successful, the panel can also transmit the FTC restore reporting code and all previous unsuccessful events.</p>
5	<p><b>Zone Fault (including Fire Zone):</b> If any zone on the system is in the Trouble state, this trouble will be generated. For hardwired zones (excluding Fire) using double end of line supervision, this is the shorted state. If DEOL is not used, Zone Troubles can still be generated on Fire Zones (open state). If [5] is pressed in the Trouble mode, the keypad will now display all of the zones in trouble. Fire Zone Faults are identified in the Event Buffer. They log a "Fault Zone X" followed by a generic "Fire Trouble". This has been done so that intermittent wiring problems may be tracked down via the Event Buffer.</p> <p>This trouble will be generated and displayed in the armed state if a Fire trouble is present. It will also restart the Trouble beeps. If any zone enters this Trouble state (short), the keypad buzzers will sound trouble beeps to annunciate the condition.</p>
6	<p><b>Zone Tamper:</b> This trouble is used with DEOL Zone Supervision only. If any zone is in the Tamper state, this trouble will be generated. Zones excluded from this are Fire and zones not supporting the DEOL configuration (LINKS answer, Key-switch). Press [6] in the Trouble mode to display all of the tampered zones. If any zone enters this Tamper state (open), the keypad buzzers will sound trouble beeps to annunciate the condition.</p>
7	<p><b>Not Used</b></p>
8	<p><b>Loss of System Time:</b> When the panel is powered up, the internal clock needs to be set to the correct time. This trouble is cleared when an attempt is made to reset the clock.</p>

**[\*][3] Alarm Memory**

When Disarmed, press [\*] then [3] to enter the alarm memory mode. The "Memory" light will flash and any alarm caused during the last armed period will be displayed on the zone lights.

Press [#] to return to the "Ready" mode. If [#] is not pressed, the keypad will time out in 30 seconds.

There is no memory of previous armed states. The Event Buffer can be used to achieve this function.

**[\*][4] Door Chime On/Off Command**

When Armed/Disarmed, to turn the feature on or off, enter [\*][4]. The Door Chime feature is used to sound a tone from the keypad whenever a zone programmed as a Chime type is activated. When the Door Chime feature is turned ON, the keypad will beep several times whenever a Chime zone is activated. When the feature is being turned ON, the keypad will beep 3 times and the LCD will display "Door Chime Feature ON". When the feature is being turned OFF, the keypad will sound a single long tone and the LCD keypad will display "Door Chime Feature OFF".

**[\*][5] Program User Codes**

The following table identifies available user codes:

Code	Type	Function
[01] – [39]	General User Codes	Determined by attributes programmed below
[40]	Master Code	

When Disarmed, enter [\*][5] to access the attribute programming mode.

- 1) The default attributes of a new code will be the attributes of the code used to enter [\*][5] whether it is a new code or an existing code being programmed.
- 2) All user codes will now have a check so that they cannot be + or -1 of any other code.

### Inherent Attributes (All codes except Installer and Maintenance)

Arm/Disarm - Any access code is valid for arming and disarming.

Command Outputs [\*][7][1] - If the output requires an access code entry, any valid access code can be used.

### Programmable Attributes ([\*][5][Master/Supervisor Code][99][Code])

[1] Supervisor's Code – This code is used for validation when entering the [\*][5] User Code Programming section. However, this code can only program codes which have equal or lesser attributes. These attributes are changeable.

[2] Duress Code – Duress codes are standard user codes that will transmit the Duress Reporting Code whenever the code is entered to perform any function on the system.

Duress codes are not valid when entering [\*][5], [\*][6] or [\*][8] sections.

A code cannot be programmed as a duplicate or as a code + or -1.

[3] Zone Bypassing Enabled – This attribute controls whether the user can bypass zones. This also requires that option Code Required for Bypassing option is turned ON.

[4] Remote Access – This attribute controls access to the system via a telephone during remote access.

[5] For Future Use

[6] For Future Use

[7] Bell Squawk upon Arming/Disarming – This attribute is used to determine whether an access code should generate an arming/disarming bell squawk at the end of exit delay. The attribute is off at default for all access codes, and this feature is meant to be used when Bell Squawk on Arming/Disarming is disabled in Section [014]. However, if the away function key is pressed on the system keypad, followed by an access code with this attribute enabled, the bell will still squawk.

[8] One-Time-Use Code – When the one-time-use code is entered on the system, the user of the code will be able to arm the panel with the code as many times as they want. They will also be able to disarm the system using the code once per day. The disarming operation will be reset at midnight, or if the code or its attributes are viewed in the [\*][5] Access Code Programming. A code programmed as one-time use can be used to access other star menus that require an access code.

### Notes on Access Codes and Programming

**Note:** [\*][5][MASTER CODE] [01 to 39 40] to program access codes.

[\*][5][MASTER CODE][99] enters the Attribute Mode [01 to 39] to edit access code attributes.

**Note:** The Master Code's attributes cannot be changed.

**Note:** When a new code is programmed in either [\*][5] or through Installer Programming, it will be checked against all other codes in the system. If a duplicate code is found, an error tone is given, and the code is returned to what it was before it was changed. This applies to both 4- and 6-digit codes.

**Note:** In [\*][5] if a duress code is being programmed, it will be checked to make sure that it is not 1 digit more than any other code in the system. This will only apply to the least significant digit and does not roll over to the next digit. If a user code is 1234, then the duress codes 1234 and 1235 are not allowed. If the user code is 1239, then duress cannot be 1239 or 1230, but could be 1240. This applies to both 4- and 6-digit codes.

**Note:** See also [006] Installer Code and [008] Maintenance Code.

### Erasing an Access Code

To erase an access code, the user will have to go into the base menu and then select the user number and enter [\*] as the first digit. If [\*] is entered, the system will delete the code immediately and the user will be returned to select another code.

## [\*][6] – User Functions

To access the User Functions section, when disarmed, press [\*][6] followed by the master or supervisor code. Select one of the functions described below by pressing the corresponding number or scrolling to the desired option then pressing [\*].

- [1] **Program Time and Date:** Enter the time and date using the following format [HH:MM] [MM/DD/YY]. Program the time using military standard (e.g., 8:00 pm = 20:00 hours). Valid entries for the Hour are 00-23. Valid entries for the Minute are 00-59.
- [2] **Auto-Arm Control:** Pressing [2] while in the User Function menu will enable (3 beeps) or disable (one long beep) the Auto-Arm feature. With this feature enabled, the panel will automatically arm in the Away mode (Stay Away zones active) at the same time each day. The Auto-Arm time is programmed with the [\*][6][Master Code][3] command.  
**Note:** Keypads are required if Auto-Arm is to be used.
- [3] **Auto-Arm Time:** The system can be programmed to arm at the same time each day. Upon entry of this section, enter 4 digits for the 24 Hour Auto-Arm time. At the selected Auto-Arm time, the Keypad Buzzers will sound for the programmed time in Section [199] to warn that an Auto-Arm is in progress. The bell can also be programmed to squawk once every 10 seconds during this warning period. When the warning period is complete, the system will arm with no exit delay and in the Away Mode. Auto-Arming can be cancelled or postponed only by entering a valid access code during the programmed warning period. When the code has been entered, the warning will be silenced and Auto-Arming will be canceled or postponed, depending on the Programming of Section [175]. Auto-Arming will be attempted at the same time the next day. Whenever the Auto-Arming process is cancelled or postponed, the Auto-Arm Cancellation Reporting Code will be transmitted (if programmed).  
The Auto-Arm Cancellation will be transmitted if arming is inhibited by one of the following:
- AC/DC Inhibit Arm
  - Latching System Tamper
  - Zone Expander Supervisory Fault.
- PC1404 only supports one entry of Auto-Arm Time programming, which means the programmed time shall be used for every day auto arm.
- [4] **System Test:** The system's Bell Output (2 sec), Keypad Lights and Communicator are tested. This test will also measure the panel's standby battery. The system activates the siren output on medium volume for 2 seconds followed by full volume alarm for 2 seconds. All display lights and LCD pixels turn on. When the System Test event is successfully received at the monitoring station, the keypad will sound ringback, a series of 8 beeps.
- [5] **System Serv/DLS:** If enabled, this opens a window where incoming rings on the phone line are detected by the panel. This window remains open for 6 hours. After the window has expired, DLS access will not be permitted.
- [6] **User Call-up:** If enabled by the installer, when this command is executed, the panel will make 1 attempt to call the downloading computer. The downloading computer must be waiting for the panel to call before downloading can be performed.
- [7]-[0] **For Future Use**

## Additional Keypad Functions

The following additional keypad functions are available:

<b>Event Buffer:</b>	View the 128-event panel buffer
<b>Brightness Control:</b>	Adjust the display backlighting level for optimal viewing
<b>Contrast Control:</b>	Adjust the display contrast level for optimal viewing
<b>Buzzer Control:</b>	Adjust the keypad buzzer tone for optimal sound

## [\*][7] – Command Outputs

When armed or disarmed, press [\*][7] followed by the command output number 1 to 4. When any command output is activated, three acknowledgement beeps are heard. The system can be configured to require a valid access code to activate a command output.

## [\*][8] – Installer Programming

When disarmed, press [\*][8][Installer Code] to enter Installer Programming. Installer Programming allows the installer to program all system functions. Refer to Section 4.1 Installer Programming for details. The PC1404 v1.1 is completely programmable from any system keypad using this command.

**Note:** Three-digit entries are required for section entry. When an error is made in attempting to enter a section number, [#] can be pressed. If [#] is the first digit pressed, however, the keypad will return to the base menu.

**Note:** Once inside Installer Programming, the keypad will remain there for 20 minutes after the last keypress.

**Note:** All system events that occur while in Installer Programming will be logged to the Event Buffer and printed on the system printer; however, these events will not be transmitted.

**Note:** When viewing data in sections with an LCD keypad, use the [<] and [>] keys to scroll. If using an LED keypad, press the [F] key to scroll.

## [\*][9][User Code] – No-Entry Arming

When disarmed, entering [\*][9] or pressing a function key programmed for No Entry Arm before entering an access code arms the panel without any entry delay on the perimeter delay zones and bypasses zones that are defined as "Stay Away". This command is used to arm the system while at home. When the system is armed in this mode, the "Armed" light will be ON flashing and the bypass light will be on to indicate the "Stay Away" zones are bypassed. Once the panel is armed in this mode, using [\*][1] will remove the bypass from the "Stay Away" zones if they were NOT manually bypassed. The [\*][1] command used here only removes the bypass from zones

that have been automatically bypassed with the [\*][9] command. Delay Stay/Away and Interior Delay Zones will still have Entry Delay on a [\*][9] armed panel.

**[\*][0] – Quick Arm**

When disarmed, press [\*][0] to activate Quick Arm. Quick Arm may be used as a convenience for regular users or when the system is to be armed by individuals who are not authorized to disarm the system. This panel will log either "Armed in Stay Mode" or "Armed in Away Mode" for this closing type.

**[\*][0] – Quick Exit**

When armed, press [\*][0] to activate Quick Exit. Quick Exit allows the user 2 minutes to exit the premises through any delay zone without altering the status of the system if the Quick Exit feature is enabled. After [\*][0] is entered, one and only one delay zone may be tripped. If the delay zone is left unrestored at the end of the 2 minutes, it will begin its entry delay sequence. Any additional activity on any other active zone will cause that zone to begin its alarm or delay sequence. Quick Exit is not designed to extend the standard Exit Delay.

## 4 Programming

The PC1404 can be programmed using the following methods:

Programming Method	Description	Procedure
Installer Programming	Allows direct access to all programming sections.	Press [*][8][Installer's Code] while the system is disarmed. See 4.1 Installer Programming for details.
DLS Programming	Allows programming to be downloaded using DLS-V™ software. DLS programming can be performed locally with a PC-Link cable and a PC with DLS-V software installed. DLS programming can be performed remotely via telephone line.	DLS Programming can be set up from Installer Programming (see [401] Downloading Option Codes). <b>Note:</b> Panel communications will interfere with the PC-link connection. Ensure the PC1404 is not communicating before attempting a local DLS connection.

### 4.1 Installer Programming

The following section of the manual describes the Installer Programming functions and how to program the various sections.

Read the following section of the manual very carefully before you begin programming. We also recommend filling out the Programming Worksheets section before you program the panel.

Installer Programming is used to program all communicator and panel options. The Installer Code is [5555] by default (555555 if 6 digit codes are used) but should be changed to prevent unauthorized access to programming.

From an LED or fixed message LCD keypad:

- Enter [\*][8][Installer Code].  
The Program light (or System light on the PC1555RKZ) will flash to indicate that you are in programming mode.  
The Armed light will turn on to indicate that the panel is waiting for the three-digit programming section number.
- Enter the three-digit section number corresponding to the section you wish to program.  
The Armed light will turn off.  
The Ready light will turn on to indicate that the panel is waiting for the information required to complete programming the selected section.
- Enter the information required to complete section programming (i.e., numbers, HEX data, or ON/OFF options).

**Note:** If the three-digit section number entered is invalid, or if the module which pertains to the section is not present, the keypad will sound a two second error tone.

From an LCD keypad:

- From any keypad, enter [\*][8][Installer Code]. The Keypad will display 'Enter Section' followed by three dashes.
- Enter the three-digit number corresponding to the programming section number you wish to program. The keypad will now display the information required to complete programming the selected section.
- Enter the information required to complete section programming (i.e., numbers, HEX data, or ON/OFF options).

If you enter information into a section and make a mistake, press the [#] key to exit the section. Select that section again and re-enter the information correctly.

**Note:** There must be one digit in each box in the programming section in order for the change to be valid.

### 4.2 Programming Decimal Data

A set number of programming boxes are allotted for each section requiring decimal data (e.g.: codes, telephone numbers). If a digit is entered for each program box, the panel will automatically exit from the selected programming section. The Ready light will turn OFF and the Armed light will turn ON.

On the PC1555RKZ and PK5508 keypads, you can also press the [#] key to exit a programming section without entering data for every box. This is handy if you only need to change digits in the first few programming boxes. All other digits in the programming section will remain unchanged.

### 4.3 Programming HEX Data

On occasion, hexadecimal (HEX) digits may be required. To program a HEX digit, press the [\*] key. The panel will enter HEX programming and the Ready light will begin to flash.

The following are the numbers that should be pressed to enter the appropriate HEX digit:

1 = A      2 = B      3 = C      4 = D      5 = E      6 = F

Once the correct HEX digit has been entered, the Ready light will continue to flash. If another HEX digit is required, press the corresponding number. If a decimal digit is required, press the [\*] key again. The Ready light will turn on and the panel will return to regular decimal programming.

#### Example:

To enter 'C1' for a closing by user 1, you would enter:

[\*][3][\*], [1]:

[\*] to enter Hexadecimal mode (Ready light flashes)

[3] to enter C

[\*] to return to decimal mode (Ready light is solid)

[1] to enter digit 1

**Note:** If Ready light is flashing, any number you enter will be programmed as the HEX equivalent.

If you are using a pulse communications format, a decimal zero [0] does not transmit. Programming a zero [0] tells the panel not to send any pulses for that digit. Decimal zero [0] is a filler digit. To transmit a zero [0], it must be programmed as a Hexadecimal 'A'.

**Example:**

For the three digit account number '403', you would enter:

[4], [\*][1][\*][3], [0]:

[4] to enter the digit 4

[\*] to enter Hexadecimal mode (Ready light flashes)

[1] to enter A

[\*] to return to decimal mode (Ready light is solid)

[3] to enter the digit 3

[0] to enter the digit 0 as a filler digit.

#### 4.4 Programming Toggle Option Selections

Some programming sections contain several toggle options. The panel will use zone lights 1 through 8 to indicate if the different options are enabled or disabled. Press the number corresponding to the option to turn it ON or OFF. Once all the toggle options have been selected correctly, press the [#] key to exit the section and save the changes. The Ready light will turn OFF and the Armed light will turn ON.

Refer to the Programming Worksheets in this manual to determine what each option represents and whether the light should be ON or OFF for your application.

#### 4.5 Viewing Programming

##### LED and Fixed Message LCD Keypads

Any programming section can be viewed from an LED keypad. When a programming section is entered, the keypad will immediately display the first digit of information programmed in that section. The keypad displays the information using a binary format, according to the following chart.

Please See Hex Data Entry  
Instructions Below

Value	0	1	2	3	4	5	6	7	8	9	A	B	C	D	E	F
Zone 1	<input type="checkbox"/>	<input checked="" type="checkbox"/>	<input type="checkbox"/>	<input checked="" type="checkbox"/>	<input type="checkbox"/>	<input checked="" type="checkbox"/>	<input type="checkbox"/>	<input checked="" type="checkbox"/>	<input type="checkbox"/>	<input checked="" type="checkbox"/>	<input type="checkbox"/>	<input checked="" type="checkbox"/>	<input type="checkbox"/>	<input checked="" type="checkbox"/>	<input type="checkbox"/>	<input checked="" type="checkbox"/>
Zone 2	<input type="checkbox"/>	<input type="checkbox"/>	<input checked="" type="checkbox"/>	<input checked="" type="checkbox"/>	<input type="checkbox"/>	<input type="checkbox"/>	<input checked="" type="checkbox"/>	<input checked="" type="checkbox"/>	<input type="checkbox"/>	<input type="checkbox"/>	<input checked="" type="checkbox"/>	<input checked="" type="checkbox"/>	<input type="checkbox"/>	<input type="checkbox"/>	<input checked="" type="checkbox"/>	<input checked="" type="checkbox"/>
Zone 3	<input type="checkbox"/>	<input type="checkbox"/>	<input type="checkbox"/>	<input type="checkbox"/>	<input type="checkbox"/>	<input type="checkbox"/>	<input type="checkbox"/>	<input type="checkbox"/>	<input type="checkbox"/>	<input type="checkbox"/>	<input type="checkbox"/>	<input type="checkbox"/>	<input type="checkbox"/>	<input type="checkbox"/>	<input type="checkbox"/>	<input type="checkbox"/>
Zone 4	<input type="checkbox"/>	<input type="checkbox"/>	<input type="checkbox"/>	<input type="checkbox"/>	<input type="checkbox"/>	<input type="checkbox"/>	<input type="checkbox"/>	<input type="checkbox"/>	<input type="checkbox"/>	<input type="checkbox"/>	<input type="checkbox"/>	<input type="checkbox"/>	<input type="checkbox"/>	<input type="checkbox"/>	<input type="checkbox"/>	<input type="checkbox"/>

Zone Light OFF  
 Zone Light ON

Press the Fire keys to advance to the next digit. When all the digits in a section have been viewed, the panel will exit the section; the Ready Light will turn OFF and the Armed light will turn ON, waiting for the next three-digit programming section number to be entered. Press the [#] key to exit the section.

#### LCD Keypad

When a programming section is entered, the keypad will immediately display all the information programmed in that section. Use the arrow keys (<>) to scroll through the data being displayed. Scroll past the end of the data displayed or press the [#] key to exit the section.

#### 4.6 DLS Programming

##### 4.6.1 Local Programming with PC-Link

Follow the steps in the sequence indicated below to set up local programming using DLS:

1. Initiate a DLS PC-Link session on the DLS computer.
2. Connect the PC-Link cable between the computer and the header pins on the alarm system.
3. When the session is complete, remove the PC-Link cable from the alarm system.
4. Complete installation.

**Note:** Connecting the DLS PC to the system automatically initiates the connection.



## 5 Programming Worksheets

Note: For more details, see PC1404 Programming Descriptions in the Technical Library section of <http://www.dsc.com>.

### 5.1 Index to Programming Worksheets

Programming Option	PWS	Programming Option	PWS
[000] Keypad Function Key Programming .....	19	[367] Opening/Closing Comm. Call Directions.....	28
[001] Zone Definitions .....	19	[375] System Maint. Alarm/Rest. Comm Call Dir. ....	28
[005] System Times .....	20	[376] System Test Trans. Comm. Call Directions.....	28
[006] Installer Code.....	20	[377] Communication Variables .....	28
[007] Master Code .....	20	[378] Test Transmission Time of Day .....	28
[008] Maintenance Code.....	20	[380] First Communicator Options .....	28
[009] PGM Output Prog. ....	20	[381] Second Communicator Options .....	29
[010] PC5208 PGM Output Prog .....	20	[382] Third Communicator Options .....	29
[011] PC5204 PGM Output Programming.....	21	[383] Fourth Communicator Options.....	29
[012] Keypad Lockout Options.....	21	[401] Downloading Option Codes .....	29
[013] First System Options.....	21	[402] Downloading Computer's Tel. Number .....	30
[014] Second System Options .....	21	[403] Downloading Access Code .....	30
[015] Third System Options .....	21	[404] Panel ID Code.....	30
[016] Fourth System Options .....	21	[405] Answering Machine Double Call Timer .....	30
[017] Fifth System Options.....	22	[406] Number of Rings to Answer On .....	30
[018] Sixth System Options.....	22	<b>PGM Output Attributes</b> .....	30
[020] Keypad Zone Assignments .....	22	[501]-[502] Main Board .....	30
[022] Ninth System Options .....	22	[503]-[510] PC5208.....	30
[023] Tenth System Options.....	22	[511]-[514] PC5204 .....	30
[030] Zone Loop Response Options .....	23	[551]-[564] PGM Zone Assignment.....	31
[101]-[108] Zone Attributes.....	23	[601] Closing (Arming) Reporting Codes .....	32
[168] Daylight Savings Time Begins .....	24	[605] Opening (Disarming) Reporting Codes.....	32
[169] Daylight Savings Time Ends .....	24	[700] Automatic Clock Adjust .....	32
[170] PGM Output Timer.....	24	[701] First International Options.....	32
[175] Auto-Arm Postpone Timer.....	24	[702] Second International Options.....	32
[176] Cross Zone/Police Code Timer .....	25	[703] Delay Between Dialing Attempts.....	32
[181] Auto-Arm Time of Day.....	25	[900] Panel Version.....	32
[190] No Activity Arming Pre-Alert Timer.....	25	[901] Installer Walk Test Mode Enable/Disab.....	32
[191] No Activity Arming Timer .....	25	[902] Module Supervision Reset.....	32
[199] Auto-Arming Pre-Alert.....	25	[903] View Module Supervision.....	32
[301] First Telephone Number.....	25	[990] Installer Lockout Enable.....	32
[302] Second Telephone Number .....	25	[991] Installer Lockout Disable.....	33
[303] Third Telephone Number .....	25	[999] Restore Panel Factory Default Prog. ....	33
[304] Call Waiting Cancel String .....	25		
[305] Fourth Telephone Number .....	25		
[310] System Account Code.....	25		
[320] Alarm Rep. Codes.....	25		
[324] Alarm/Restore Rep. Codes .....	25		
[328] Misc. Alarm Rep. Codes .....	25		
[329] Priority Alarm/Restore Rep. Codes .....	26		
[330] Tamper Rep. Codes .....	26		
[334] Tamper Restore Rep. Codes .....	26		
[338] Misc. Tamper Rep Codes.....	26		
[339]-[340] Closing (Arming) Rep. Codes .....	26		
[341] Misc. Closing (Arming) Rep. Codes.....	26		
[342]-[343] Opening (Disarming) Rep. Codes .....	26		
[344] Misc. Opening (Disarming) Rep. Codes .....	27		
[345] Maintenance Alarm Rep. Codes .....	27		
[346] Maintenance Restore Rep. Codes.....	27		
[347] Misc. Maintenance Rep. Codes .....	27		
[348] Test Transmission Rep. Codes .....	27		
[350] Communicator Format Options.....	27		
[351] Alarm/Rest. Comm. Call Directions.....	27		
[359] Tamper Alarm/Rest. Comm. Call Directions.....	27		

## 5.2 Programming Worksheets

### Keypad Partition/Slot and Function Key Programming

#### [000] Function Key Programming

**Note:** Keypad enrollment must be done at each keypad requiring programming. Function keys are programmable in each individual keypad. The keypad being programmed must be used to access Installer Programming, followed by Section [000] and digits 1-5 for function keys 1 to 5.

[0] Slot address	For the partition, 0-8; for the slot, 1-8. For example, to enroll a keypad on the main partition and slot 6, enter 16.
[1] Function Key 1 Assignment	Valid entries are 00-25
[2] Function Key 2 Assignment	Valid entries are 00-25
[3] Function Key 3 Assignment	Valid entries are 00-25
[4] Function Key 4 Assignment	Valid entries are 00-25
[5] Function Key 5 Assignment	Valid entries are 00-25

#### Function Key Options

- |                                 |  |                                       |
|---------------------------------|--|---------------------------------------|
| <b>00</b> Null Key              | <b>09</b> Future Use                               | <b>18</b> Future Use                  |
| <b>01</b> Future Use            | <b>10</b> Future Use                               | <b>19</b> [*][7][3] Command Output #3 |
| <b>02</b> Future Use            | <b>11</b> Future Use                               | <b>20</b> Night Arm                   |
| <b>03</b> Stay Arm              | <b>12</b> Future Use                               | <b>21</b> [*][7][4] Command Output #4 |
| <b>04</b> Away Arm              | <b>13</b> [*][7][1] Command Output #1              | <b>22</b> Future Use                  |
| <b>05</b> [*][9] No Entry Arm   | <b>14</b> [*][7][2] Command Output #2/Sensor Reset | <b>23</b> Future Use                  |
| <b>06</b> [*][4] Chime On / Off | <b>15</b> Future Use                               | <b>24</b> Future Use                  |
| <b>07</b> Future Use            | <b>16</b> [*][0] Quick Exit                        | <b>25</b> Instant Stay Arm*           |
| <b>08</b> [*][1] Bypass Mode    | <b>17</b> [*][1] Reactivate Stay/Away Zones        | <b>26-33</b> Future Use               |

\*This function key must not be used in CP-01 listed systems.

	Key 1	Key 2	Key 3	Key 4	Key 5
<b>Keypad Defaults</b>	03 ___	04 ___	06 ___	08 ___	16 ___

#### [001] Zone Definitions

- |                                       |   |                                      |
|---------------------------------------|---|--------------------------------------|
| <b>00</b> Null Zone (Not Used)        | <b>14</b> 24 Hour Heat*                   | <b>28</b> Not Used                   |
| <b>01</b> Delay 1*                    | <b>15</b> 24 Hour Medical*                | <b>29</b> Auto-verified fire         |
| <b>02</b> Delay 2*                    | <b>16</b> 24 Hour Panic*                  | <b>30</b> Not Used                   |
| <b>03</b> Instant*                    | <b>17</b> 24 Hour Emergency*              | <b>31</b> Day Zone                   |
| <b>04</b> Interior*                   | <b>18</b> Not Used                        | <b>32</b> Instant Stay/Away*         |
| <b>05</b> Interior, Stay/Away*        | <b>19</b> 24 Hour Water*                  | <b>33</b> Not Used                   |
| <b>06</b> Delay, Stay/Away*           | <b>20</b> 24 Hour Freeze*                 | <b>34</b> Not Used                   |
| <b>07</b> Delayed 24 Hr. Fire         | <b>21</b> 24 Hour Latching Tamper         | <b>35</b> 24 Hour Bell               |
| <b>08</b> Standard 24 Hr. Fire        | <b>22</b> Momentary Keyswitch Arm*        | <b>36</b> 24 Hr. Non-Latching Tamper |
| <b>09</b> 24 Hour Supervisory         | <b>23</b> Maintained Keyswitch Arm *      | <b>37</b> Night Zone*                |
| <b>10</b> 24 Hour Supervisory Buzzer* | <b>24</b> Not Used                        | <b>41</b> 24-Hour CO Detection       |
| <b>11</b> 24 Hour Burglary*           | <b>25</b> Interior Delay*                 |                                      |
| <b>12</b> Not Used                    | <b>26</b> 24-hour Non-Alarm (Local Alarm) |                                      |
| <b>13</b> 24 Hour Gas*                | <b>27</b> Not Used                        |                                      |

\*For burglary applications only

**Note:** Don't enable cross zoning on fire zones or auto-verified fire zones (zone type 29).

#### [001] Zone 1–8 Definitions

Zone	Default	Zone	Default
01	01	05 (ZD or keypad zone only)	04
02	03	06 (ZD or keypad zone only)	04
03	03	07 (ZD or keypad zone only)	04
04	03	08 (ZD or keypad zone only)	04

**Note:** If zone doubling is enabled, keypad zones will not work.

**Note:** If zone doubling is enabled, fire zones cannot be used with zone terminals 1 to 8. Two-wire smoke detectors can still be used.

**[005] System Times**

Valid entries for Entry Delay are between 030-255. Valid entries for SIA CP-01 Exit Delay are between 045-255.

Enter 3 digits from **Default** **SIA CP-01**  
001-255 **Default**

**Subsection [01]**

_ _ _	Entry Delay 1	030	
_ _ _	Entry Delay 2	045	030
_ _ _	Exit Delay	120	060

**Subsection [09]**

_ _ _	Bell Time-out (BTO)	004	
-------	---------------------	-----	--

**Note:** If the Exit Delay is silent (Stay Arming Function Key), the exit delay is twice the programmed value but must not exceed 255 seconds (090-255 seconds).

**Note:** For UL installations, the Entry Delay plus the Transmission Delay must not exceed 60 seconds.

**[006] Installer Code**

**[007] Master Code**

**[008] Maintenance Code**

These codes are 4 or 6-digits (programmed in Section [701] Opt.[5]. For 4-digit codes, the default is the first 4 digits.

<b>Default</b>	<b>Default</b>	<b>Default</b>
555555  _ _ _ _ _ _	123456  _ _ _ _ _ _	AAAA00  _ _ _ _ _ _

**Programmable Output Options**

- |  |  |
|--|--|
| <b>00</b> Null PGM (Not Used)                          | <b>15</b> Remote Operation                 |
| <b>01</b> Burglary and Fire Output                     | <b>16</b> Not Used                         |
| <b>02</b> Not Used                                     | <b>17</b> Away Armed Status                |
| <b>03</b> Sensor Reset [*][7][2]                       | <b>18</b> Stay Armed Status                |
| <b>04</b> 2-Wire Smoke                                 | <b>19</b> Command Output #1 ([*][7][1])    |
| <b>05</b> Armed Status                                 | <b>20</b> Command Output #2 ([*][7][2])    |
| <b>06</b> Ready To Arm                                 | <b>21</b> Command Output #3 ([*][7][3])    |
| <b>07</b> Keypad Buzzer Follow                         | <b>22</b> Command Output #4 ([*][7][4])    |
| <b>08</b> Courtesy Pulse                               | <b>25</b> Delayed Fire and Burglary Output |
| <b>09</b> System Trouble Output (with Trouble Options) | <b>26</b> Not Used                         |
| <b>10</b> System Event Output (with Event Options)     | <b>27</b> Police Code Output               |
| <b>11</b> System Tamper (all sources: zones, keypad)   | <b>29</b> Zone Follower Output (Zones 1–8) |
| <b>12</b> TLM and Alarm                                | <b>30</b> Status Alarm Memory Output       |
| <b>13</b> Kiss-off                                     | <b>31-32</b> Not Used                      |
| <b>14</b> Ground Start Pulse                           |  |

**[009] Main Board PGM Output Programming (PGM 1 & 2)**

**Default**

19	_ _ _ _	Onboard PGM 1 Type
10	_ _ _ _	Onboard PGM 2 Type

**[010] PC5208 PGM Output Programming**

**Default**

01	_ _ _ _	PGM 3
01	_ _ _ _	PGM 4
01	_ _ _ _	PGM 5
01	_ _ _ _	PGM 6
01	_ _ _ _	PGM 7
01	_ _ _ _	PGM 8
01	_ _ _ _	PGM 9
01	_ _ _ _	PGM 10

**[011] PC5204 PGM Output Programming****Default**

01     |\_\_\_\_\_| PGM 11  
 01     |\_\_\_\_\_| PGM 12  
 01     |\_\_\_\_\_| PGM 13  
 01     |\_\_\_\_\_| PGM 14

**[012] Keypad Lockout Options**

**Note:** If Keypad Lockout is active, the panel CANNOT be disarmed with a keyswitch.

**Default**

000     |\_\_\_\_\_| Number of Invalid Codes Before Lockout     (Valid entries are 000-255)  
 000     |\_\_\_\_\_| Lockout Duration (in minutes)     (Valid entries are 000-255)

**[013] First System Options**

Opt.	Def.	ON	OFF
1	<input type="checkbox"/>	Normally Closed Loops	<input checked="" type="checkbox"/> <input type="checkbox"/> End-of-line Resistors
2	<input type="checkbox"/>	Double End-of-Line Resistors	<input checked="" type="checkbox"/> <input type="checkbox"/> Single End-of-line Resistors
3	<input checked="" type="checkbox"/>	Panel Shows All Troubles While Armed	<input type="checkbox"/> Panel Shows Fire Troubles While Armed
4	<input type="checkbox"/>	Tampers/Faults Do Not Show as Open	<input checked="" type="checkbox"/> <input type="checkbox"/> Tampers/Faults Show As Open
5	<input checked="" type="checkbox"/>	Auto-Arm Schedule in [*][6] + Installer Prog.	<input type="checkbox"/> Auto-Arm Schedule in Installer Prog. Only
6	<input checked="" type="checkbox"/>	Audible Exit Fault Enabled	<input type="checkbox"/> Audible Exit Fault Disabled
7	<input type="checkbox"/>	Zone Doubling Enabled	<input checked="" type="checkbox"/> <input type="checkbox"/> Zone Doubling Disabled
8	<input type="checkbox"/>	Temporal Three Fire Signal Enabled	<input checked="" type="checkbox"/> <input type="checkbox"/> Standard Pulsed Fire Signal

**Note:** When Option 7 is ON, the configuration of Options 1 and 2 should be ignored.

**[014] Second System Options**

Opt.	Def.	ON	OFF
1	<input type="checkbox"/>	Arm/Disarm Squawk Enabled	<input checked="" type="checkbox"/> <input type="checkbox"/> Arm/Disarm Squawk Disabled
2	<input type="checkbox"/>	Bell Squawk During Auto Arm On	<input checked="" type="checkbox"/> <input type="checkbox"/> Bell Squawk During Auto Arm Off
3	<input type="checkbox"/>	For Future Use	<input checked="" type="checkbox"/> <input type="checkbox"/>
4	<input type="checkbox"/>	For Future Use	<input checked="" type="checkbox"/> <input type="checkbox"/>
5	<input type="checkbox"/>	For Future Use	<input checked="" type="checkbox"/> <input type="checkbox"/>
6	<input type="checkbox"/>	For Future Use	<input checked="" type="checkbox"/> <input type="checkbox"/>
7	<input type="checkbox"/>	Exit Delay Termination Enabled	<input checked="" type="checkbox"/> <input type="checkbox"/> Exit Delay Termination Disabled
8	<input type="checkbox"/>	Fire Bell is Continuous	<input checked="" type="checkbox"/> <input type="checkbox"/> Fire Bell Follows Bell Cut-off

**[015] Third System Options**

Opt.	Def.	ON	OFF
1	<input checked="" type="checkbox"/>	<input type="checkbox"/> [F] Key Enabled	<input type="checkbox"/> [F] Key Disabled
2	<input type="checkbox"/>	<input type="checkbox"/> [P] Key Audible (Bell/Beeps)	<input checked="" type="checkbox"/> <input type="checkbox"/> [P] Key Silent
3	<input type="checkbox"/>	Quick Exit Enabled	<input checked="" type="checkbox"/> <input type="checkbox"/> Quick Exit Disabled
4	<input checked="" type="checkbox"/>	Quick Arming Enabled ([*][0] and Function Keys)	<input type="checkbox"/> Quick Arming Disabled (Function Key Requires Code)
5	<input type="checkbox"/>	Code Required for Bypassing	<input checked="" type="checkbox"/> <input type="checkbox"/> No Code Required
6	<input type="checkbox"/>	Master Code Not Changeable	<input checked="" type="checkbox"/> <input type="checkbox"/> Master Code Changeable
7	<input checked="" type="checkbox"/>	TLM Enabled	<input type="checkbox"/> TLM Disabled
8	<input type="checkbox"/>	For Future Use	<input checked="" type="checkbox"/> <input type="checkbox"/>

**[016] Fourth System Options**

Opt.	Def.	ON	OFF
1	<input checked="" type="checkbox"/>	<input type="checkbox"/> AC Trouble Displayed	<input type="checkbox"/> AC Trouble Not Displayed
2	<input type="checkbox"/>	Trouble Light Flashes if AC Fails	<input checked="" type="checkbox"/> <input type="checkbox"/> Trouble Light Does Not Flash if AC Fails
3	<input type="checkbox"/>	Blank Keypad When Not Used	<input checked="" type="checkbox"/> <input type="checkbox"/> Keypad Always Active
4	<input type="checkbox"/>	Code Required to Remove Keypad Blanking	<input checked="" type="checkbox"/> <input type="checkbox"/> No Code Required
5	<input checked="" type="checkbox"/>	Keypad Backlighting Enabled	<input type="checkbox"/> Keypad Backlighting Disabled

- |   |                          |                                     |   |                          |   |
|---|--------------------------|-------------------------------------|---|--------------------------|---|
| 6 | <input type="checkbox"/> | Power Save Mode Enabled             | ✓ | <input type="checkbox"/> | Power Save Mode Disabled                |
| 7 | <input type="checkbox"/> | Bypass Status Displayed While Armed | ✓ | <input type="checkbox"/> | Bypass Status Not Displayed While Armed |
| 8 | <input type="checkbox"/> | Keypad Tamper Enabled               | ✓ | <input type="checkbox"/> | Keypad Tamper Disabled                  |

**[017] Fifth System Options**

- | Opt. | Def.                     | ON                            |   | OFF                      |                                |
|------|--------------------------|-------------------------------|---|--------------------------|--------------------------------|
| 1    | <input type="checkbox"/> | For Future Use                | ✓ | <input type="checkbox"/> |                                |
| 2    | <input type="checkbox"/> | For Future Use                | ✓ | <input type="checkbox"/> |                                |
| 3    | <input type="checkbox"/> | For Future Use                | ✓ | <input type="checkbox"/> |                                |
| 4    | <input type="checkbox"/> | Double Hit Enabled            | ✓ | <input type="checkbox"/> | Double Hit Disabled            |
| 5    | <input type="checkbox"/> | Late to Close Enabled         | ✓ | <input type="checkbox"/> | Late to Close Disabled         |
| 6    | <input type="checkbox"/> | Daylight Savings Time Enabled | ✓ | <input type="checkbox"/> | Daylight Savings Time Disabled |
| 7    | <input type="checkbox"/> | For Future Use                | ✓ | <input type="checkbox"/> |                                |
| 8    | <input type="checkbox"/> | For Future Use                | ✓ | <input type="checkbox"/> |                                |

**[018] Sixth System Options**

- | Opt. | Def.                     | ON   |   | OFF                      |   |
|------|--------------------------|--|---|--------------------------|---|
| 1    | <input type="checkbox"/> | For Future Use   | ✓ | <input type="checkbox"/> |   |
| 2    | <input type="checkbox"/> | For Future Use   | ✓ | <input type="checkbox"/> |   |
| 3    | <input type="checkbox"/> | For Future Use   | ✓ | <input type="checkbox"/> |   |
| 4    | <input type="checkbox"/> | For Future Use   | ✓ | <input type="checkbox"/> |   |
| 5    | <input type="checkbox"/> | Keypad Buzzer Follows Bell Enabled                     | ✓ | <input type="checkbox"/> | Keypad Buzzer Follows Bell Disabled         |
| 6    | <input type="checkbox"/> | Cross Zoning Enabled                                   | ✓ | <input type="checkbox"/> | Cross Zoning Disabled (Police Code Enabled) |
| 7    | <input type="checkbox"/> | Exit Delay Restart Enabled ( <b>ON for SIA CP-01</b> ) | ✓ | <input type="checkbox"/> | Exit Delay Restart Disabled                 |
| 8    | <input type="checkbox"/> | System AC Failure Trouble Beeps Enabled                | ✓ | <input type="checkbox"/> | System AC Failure Trouble Beeps Disabled    |

**[020] Keypad Zone Assignments**

**Default**

- |    |           |                         |                                 |
|----|-----------|-------------------------|---------------------------------|
| 00 | ____ ____ | Keypad (Address 1) Zone | (Valid entries are Zones 01–08) |
| 00 | ____ ____ | Keypad (Address 2) Zone |                                 |
| 00 | ____ ____ | Keypad (Address 3) Zone |                                 |
| 00 | ____ ____ | Keypad (Address 4) Zone |                                 |
| 00 | ____ ____ | Keypad (Address 5) Zone |                                 |
| 00 | ____ ____ | Keypad (Address 6) Zone |                                 |
| 00 | ____ ____ | Keypad (Address 7) Zone |                                 |
| 00 | ____ ____ | Keypad (Address 8) Zone |                                 |

**[022] Ninth System Options**

- | Opt | Def.                     | ON                                |   | OFF                      |  |
|-----|--------------------------|-----------------------------------|---|--------------------------|--|
| 1   | <input type="checkbox"/> | For Future Use                    | ✓ | <input type="checkbox"/> |  |
| 2   | <input type="checkbox"/> | For Future Use                    | ✓ | <input type="checkbox"/> |  |
| 3   | <input type="checkbox"/> | Auto-Arming Force-Arms Open Zones | ✓ | <input type="checkbox"/> | Auto-Arming Follows Force-Arming Attribute |
| 4   | <input type="checkbox"/> | For Future Use                    | ✓ | <input type="checkbox"/> |  |
| 5   | <input type="checkbox"/> | For Future Use                    | ✓ | <input type="checkbox"/> |  |
| 6   | <input type="checkbox"/> | For Future Use                    | ✓ | <input type="checkbox"/> |  |
| 7   | <input type="checkbox"/> | For Future Use                    | ✓ | <input type="checkbox"/> |  |
| 8   | <input type="checkbox"/> | Stay Arming Exit Delay is Audible | ✓ | <input type="checkbox"/> | Stay Arming Exit Delay is Silent           |

**Note:** Option 3 should be disabled for CP-01 systems.

**[023] Tenth System Options**

- | Opt | Def.                     | ON                                   |   | OFF                      |                                      |
|-----|--------------------------|--------------------------------------|---|--------------------------|--------------------------------------|
| 1   | <input type="checkbox"/> | For Future Use                       | ✓ | <input type="checkbox"/> |                                      |
| 2   | <input type="checkbox"/> | For Future Use                       | ✓ | <input type="checkbox"/> |                                      |
| 3   | <input type="checkbox"/> | For Future Use                       | ✓ | <input type="checkbox"/> |                                      |
| 4   | <input type="checkbox"/> | For Future Use                       | ✓ | <input type="checkbox"/> |                                      |
| 5   | <input type="checkbox"/> | Switching from Away to Stay Disabled | ✓ | <input type="checkbox"/> | Away to Stay Toggle Option Permitted |
| 6   | <input type="checkbox"/> | For Future Use                       | ✓ | <input type="checkbox"/> |                                      |

- 7  Trouble Beeps are Silent
- 8  Keyswitch Arms In Away Mode Only
- Trouble Beeps Sound Every 10 seconds
- Keyswitch Arms In Stay or Away Modes

**[030] Zone Loop Response Options**

- | Opt | Def.                     | ON                           | OFF  |
|-----|--------------------------|------------------------------|--|
| 1   | <input type="checkbox"/> | Zone 1 is Fast Loop Response | <input checked="" type="checkbox"/> Zone 1 is Normal Loop Response |
| 2   | <input type="checkbox"/> | Zone 2 is Fast Loop Response | <input checked="" type="checkbox"/> Zone 2 is Normal Loop Response |
| 3   | <input type="checkbox"/> | Zone 3 is Fast Loop Response | <input checked="" type="checkbox"/> Zone 3 is Normal Loop Response |
| 4   | <input type="checkbox"/> | Zone 4 is Fast Loop Response | <input checked="" type="checkbox"/> Zone 4 is Normal Loop Response |

**[101]-[108] Zone Attributes**

- [101] Zone 1 Attributes
- [102] Zone 2 Attributes
- [103] Zone 3 Attributes
- [104] Zone 4 Attributes
- [105] Zone 5 Attributes
- [106] Zone 6 Attributes
- [107] Zone 7 Attributes
- [108] Zone 8 Attributes

**Zone Attribute Defaults**

Attribute:	1	2	3	4	5*	6**	7***	8
✓ =ON	Audible	Steady	Chime	Bypass	Force	Swing	Tx.Delay	Not used
Zone Type:	OFF	Silent	Pulsed	No	No	No	No	
00 Null Zone								
01 Delay 1	✓	✓	✓	✓		✓		
02 Delay 2	✓	✓	✓	✓		✓		
03 Instant	✓	✓	✓	✓		✓		
04 Interior	✓	✓		✓		✓		
05 Interior Stay/Away	✓	✓		✓	✓	✓		
06 Delay Stay/Away	✓	✓		✓	✓	✓		
07 Delay 24-hr. Fire (Hardwired)	✓							
08 Stand 24-hr. Fire (Hardwired)	✓							
09 24-hr. Supervisory (Hardwired)		✓			✓			
10 24-hr. Supervisory Buzzer		✓		✓				
11 24-hr. Burglary	✓	✓		✓				
12 Not Used								
13 24-hr. Gas	✓							
14 24-hr. Heat	✓							
15 24-hr. Medical	✓	✓						
16 24-hr. Panic	✓	✓						
17 24-hr. Emergency	✓	✓						
18 Not Used								
19 24-hr. Water	✓	✓						
20 24-hr. Freeze	✓	✓						
21 24-hr. Latching Tamper	✓	✓						
22 Momentary Keyswitch Arm					✓			
23 Maintained Keyswitch (Hardwired)					✓			
24 Not Used								
25 Interior Delay	✓	✓		✓		✓		
26 24-hr. Non-Alarm					✓			
27-30 Not Used								
31 Day Zone	✓	✓		✓	✓	✓	✓	
32 Instant Stay/Away	✓	✓		✓		✓		
33-34 Not Used								
35 24-hr. Bell/Buzzer Zone Type	✓	✓		✓		✓		
36 24-hr. Non-Latching Tamper		✓				✓		
37 Night Zone	✓	✓		✓	✓	✓		
41 24-hr. Carbon Monoxide Detection	✓							

\* For UL installations, do not change attribute 5 (Force Arming) from the default setting.

\*\*For CP-01 installations: Option 6 (Swinger) is defaulted ON for zone definitions 09-11, 13-17, 19, 20.

\*\*\*For CP-01 installations: Option 7 (Tx Delay) is defaulted ON for zone definitions 01-06, 09-11, 13-17, 19, 20, 25, 32, 36, 37.

Attribute:	9	10	11	12	13	14	15	16
✓ =ON	Cross Zn	Zone Attributes 10-13 for Future Use				NC Loops	SEOL	DEOL
Zone Type: OFF	No					Config.	Config.	Config.
00 Null Zone								
01 Delay 1								
02 Delay 2								
03 Instant								
04 Interior								
05 Interior Stay/Away								
06 Delay Stay/Away								
07 Delay 24-hr. Fire (Hardwired)								
08 Stand 24-hr. Fire (Hardwired)								
09 24-hr. Supervisory (Hardwired)								
10 24-hr. Supervisory Buzzer								
11 24-hr. Burglary								
12 Not Used								
13 24-hr. Gas								
14 24-hr. Heat								
15 24-hr. Medical								
16 24-hr. Panic								
17 24-hr. Emergency								
18 Not Used								
19 24-hr. Water								
20 24-hr. Freeze								
21 24-hr. Latching Tamper								
22 Momentary Keyswitch Arm								
23 Maintained Keyswitch (Hardwired)								
24 Not Used								
25 Interior Delay								
26 24-hr. Non-Alarm								
27-30 Not Used								
31 Day Zone								
32 Instant Stay/Away								
33-34 Not Used								
35 24-hr. Bell/Buzzer Zone Type								
36 24-hr. Non-Latching Tamper								
37 Night Zone								
41 24-hr. Carbon Monoxide Detection								

**[168] Daylight Saving Time Begins**

**[169] Daylight Saving Time Ends**

Default	CE Default			Valid entries	Default	CE Default			Valid entries
003	003	Month	_ _ _ _ _	001-012	011	010	Month	_ _ _ _ _	001-012
002	005	Week	_ _ _ _ _	000-005	001	005	Week	_ _ _ _ _	000-005
000	000	Day	_ _ _ _ _	000-031	000	000	Day	_ _ _ _ _	000-031
002	001	Hour	_ _ _ _ _	000-023	002	001	Hour	_ _ _ _ _	000-023
001	001	Increment	_ _ _ _ _	001-002	001	001	Decrement	_ _ _ _ _	001-002

**[170] PGM Output Timer**

Default 005 |\_|\_|\_|\_|\_|

Valid entries are 001-255 seconds

**[175] Auto-arm Postpone Timer**

Default 000 |\_|\_|\_|\_|\_|

Valid entries are 000-255 seconds, 000 to disable

**[176] Cross Zone/Police Code Timer**

Default 060 | | | | |

Valid entries are 000-255 seconds/minutes

**[181] Auto-Arm Time of Day**

Default 99:99 | | | | | | | |

Valid entries are 0000-2359 hrs, 9999 to disable

**[190] No Activity Arming Pre-alert Timer**

Default 001 | | | | |

Valid entries are 001-255 minutes, 000 for no pre-alert

**[191] System No Activity Arming Timer**

Default 000 | | | | |

Valid entries are 001-255 minutes, 000 to disable

**[199] Auto-Arming Pre-Alert Timer**

Default 004 | | | | |

Valid entries are 001-255 minutes, 000 to disable

**Communications**

**i** For Sections [301] to [348], the content of every section by default is [F].

**[301] First Telephone Number (32 Digits) (Program all unused digits with Hex F)**

| D | | | | | | | | | | | | | | | | | | | | | | | | | | | | | | | | | | | | | | | |

**[302] Second Telephone Number (32 Digits)**

| D | | | | | | | | | | | | | | | | | | | | | | | | | | | | | | | | | | | | | | | |

**[303] Third Telephone Number (32 Digits)**

| D | | | | | | | | | | | | | | | | | | | | | | | | | | | | | | | | | | | | | | | |

**[304] Call Waiting Cancel String (6 Digits)**

| | | | | | | | Default = DB70EF Program unused digits with Hex F

**[305] Fourth Telephone Number (32 Digits)**

| D | | | | | | | | | | | | | | | | | | | | | | | | | | | | | | | | | | | | | | | |

**[310] System Account Code (6 Digits)**

Enter a 4 or 6-digit account number for the system account code. Only SIA supports 6-digit account codes. If a 4-digit code is used, program the last two digits of the account code with FF.

Default = FFFFFFFF | | | | | | | |

**Reporting Codes**

**i** All Reporting Codes are defaulted "FF" unless indicated otherwise.

**[320] Alarm Reporting Codes, Zones 01-08**

Section

<b>[320]</b>	Zone 01	Zone 02	Zone 03	Zone 04	Zone 05	Zone 06	Zone 07	Zone 08

**[324] Alarm Restore Reporting Codes, Zones 01-08**

Section

<b>[324]</b>	Zone 01	Zone 02	Zone 03	Zone 04	Zone 05	Zone 06	Zone 07	Zone 08

**[328] Miscellaneous Alarm Reporting Codes**

- | | | | Duress Alarm
- | | | | Opening After Alarm
- | | | | Recent Closing
- | | | | Zone Expander Supervisory Alarm
- | | | | Zone Expander Supervisory Restore
- | | | | Cross Zone/Police Code Alarm
- | | | | Burglary Not Verified
- | | | | Alarm Cancelled



**[329] Priority Alarm and Restore Reporting Codes**

- |\_|\_|\_| Keypad [F] Fire Alarm
- |\_|\_|\_| Keypad [A] Auxiliary Alarm
- |\_|\_|\_| Keypad [P] Panic Alarm
- |\_|\_|\_| Auxiliary Input Alarm
- |\_|\_|\_| Keypad [F] Fire Restore
- |\_|\_|\_| Keypad [A] Auxiliary Restore
- |\_|\_|\_| Keypad [P] Panic Restore
- |\_|\_|\_| Auxiliary Input Restore

**[330] Tamper Reporting Codes, Zones 01-08**

Section

<b>[330]</b>	Zone 01	Zone 02	Zone 03	Zone 04	Zone 05	Zone 06	Zone 07	Zone 08
	_ _ _	_ _ _	_ _ _	_ _ _	_ _ _	_ _ _	_ _ _	_ _ _

**[334] Tamper Restore Reporting Codes, Zones 01-08**

Section

<b>[334]</b>	Zone 01	Zone 02	Zone 03	Zone 04	Zone 05	Zone 06	Zone 07	Zone 08
	_ _ _	_ _ _	_ _ _	_ _ _	_ _ _	_ _ _	_ _ _	_ _ _

**[338] Miscellaneous Tamper Reporting Codes**

- |\_|\_|\_| General System Tamper
- |\_|\_|\_| General System Tamper Restore
- |\_|\_|\_| Keypad Lockout

**[339] Closing (Arming) Reporting Codes, Access Codes 1-16**

Section

<b>[339]</b>	Code 1	Code 2	Code 3	Code 4	Code 5	Code 6	Code 7	Code 8
	_ _ _	_ _ _	_ _ _	_ _ _	_ _ _	_ _ _	_ _ _	_ _ _
	Code 9	Code 10	Code 11	Code 12	Code 13	Code 14	Code 15	Code 16
	_ _ _	_ _ _	_ _ _	_ _ _	_ _ _	_ _ _	_ _ _	_ _ _

**[340] Closing (Arming) Reporting Codes, Access Codes 17-32**

Section

<b>[340]</b>	Code 17	Code 18	Code 19	Code 20	Code 21	Code 22	Code 23	Code 24
	_ _ _	_ _ _	_ _ _	_ _ _	_ _ _	_ _ _	_ _ _	_ _ _
	Code 25	Code 26	Code 27	Code 28	Code 29	Code 30	Code 31	Code 32
	_ _ _	_ _ _	_ _ _	_ _ _	_ _ _	_ _ _	_ _ _	_ _ _

**[341] Miscellaneous Closing (Arming) Reporting Codes**

- |  |                        |
|--|------------------------|
| _ _ _  For Future Use                      | _ _ _  Partial Closing |
| _ _ _  For Future Use                      | _ _ _  Special Closing |
| _ _ _  For Future Use                      | _ _ _  Late to Close   |
| _ _ _  For Future Use                      | _ _ _  Exit Fault      |
| _ _ _  Automatic Zone Bypass, Default = 00 |                        |

**[342] Opening (Disarming) Reporting Codes, Access Codes 1-16**

Code 1	Code 2	Code 3	Code 4	Code 5	Code 6	Code 7	Code 8
_ _ _	_ _ _	_ _ _	_ _ _	_ _ _	_ _ _	_ _ _	_ _ _
Code 9	Code 10	Code 11	Code 12	Code 13	Code 14	Code 15	Code 16
_ _ _	_ _ _	_ _ _	_ _ _	_ _ _	_ _ _	_ _ _	_ _ _

**[343] Opening (Disarming) Reporting Codes, Access Codes 17-32**

Code 17	Code 18	Code 19	Code 20	Code 21	Code 22	Code 23	Code 24
□□□	□□□	□□□	□□□	□□□	□□□	□□□	□□□
Code 25	Code 26	Code 27	Code 28	Code 29	Code 30	Code 31	Code 32
□□□	□□□	□□□	□□□	□□□	□□□	□□□	□□□

**[344] Miscellaneous Opening (Disarming) Reporting Codes**

□□□	For Future Use	□□□	For Future Use
□□□	For Future Use	□□□	Auto-Arm Cancel/Postpone
□□□	For Future Use	□□□	Special Opening
□□□	For Future Use	□□□	For Future Use

**[345] Maintenance Alarm Reporting Codes**

□□□	Battery Trouble Alarm	□□□	Auxiliary Power Supply Trouble Alarm
□□□	AC Failure Trouble Alarm	□□□	For Future Use
□□□	Bell Circuit Trouble	□□□	General System Trouble
□□□	Fire Trouble Alarm	□□□	General System Supervisory

**[346] Maintenance Alarm Restore Reporting Codes**

□□□	Battery Trouble Restore	□□□	TLM Restore
□□□	AC Failure Trouble Restore	□□□	General System Trouble Restore
□□□	Bell Circuit Trouble Restore	□□□	General System Supervisory Restore
□□□	Fire Trouble Restore	□□□	System Reset (Cold Start)
□□□	Auxiliary Power Supply Trouble Restore		

**[347] Miscellaneous Maintenance Reporting Codes**

□□□	Telephone #1 FTC Restore	□□□	Delinquency Reporting Code
□□□	Telephone #2 FTC Restore	□□□	For Future Use
□□□	Event Buffer 75% Full	□□□	For Future Use
□_0_□_0_□	DLS Lead IN	□_0_□_0_□	Installer Lead Out
□_0_□_0_□	DLS Lead OUT	□_0_□_0_□	Installer Lead In
□□□	General Zone Fault Alarm	□□□	Telephone #3 FTC Restore
□□□	General Zone Fault Restore	□□□	Telephone #4 FTC Restore

**[348] Test Transmission Reporting Codes**

□□□	Walk Test End	□□□	Periodic Test Transmission
□□□	Walk Test Begin	□□□	System Test

**[350] Communicator Format Options**

1st Telephone Number      2nd Telephone Number      3rd Telephone Number      4th Telephone Number  
 Default 04 □□□      Default 04 □□□      Default 04 □□□      Default 04 □□□

01 20 BPS, 1400 Hz      02 20 BPS, 2300 Hz      03 DTMF Contact ID      04 SIA FSK

06\* Residential Dial      07 10 BPS, 1400Hz      08 10 BPS, 2300Hz      09 Private Line

\*Failure to communicate using Residential Dial will not generate an FTC trouble.

**[351] Alarm/Restore Communicator Call Directions**

Option 1 First Telephone Number (Default ON)	Option 2 Second Telephone Number (Default OFF)	Option 3 Third Telephone Number (Default OFF)	Option 4 Fourth Telephone Number (Default OFF)	Option 5-8 Future Use (Default ON)
✓	□	□	□	□

**[359] Tamper Alarm/Restore Communicator Call Directions**

Option 1 First Telephone Number (Default ON)	Option 2 Second Telephone Number (Default OFF)	Option 3 Third Telephone Number (Default OFF)	Option 4 Fourth Telephone Number (Default OFF)	Option 5-8 Future Use (Default ON)
✓	□	□	□	□

**[367] Opening/Closing Communicator Call Directions**

Option 1 First Telephone Number (Default OFF)	Option 2 Second Telephone Number (Default OFF)	Option 3 Third Telephone Number (Default OFF)	Option 4 Fourth Telephone Number (Default OFF)	Option 5-8 Future Use (Default OFF)
<input type="checkbox"/>	<input type="checkbox"/>	<input type="checkbox"/>	<input type="checkbox"/>	<input type="checkbox"/>

**[375] System Maintenance Alarm/Restore Communicator Call Directions**

Option 1 First Telephone Number (Default ON)	Option 2 Second Telephone Number (Default OFF)	Option 3 Third Telephone Number (Default OFF)	Option 4 Fourth Telephone Number (Default OFF)	Option 5-8 Future Use (Default ON)
<input checked="" type="checkbox"/>	<input type="checkbox"/>	<input type="checkbox"/>	<input type="checkbox"/>	<input type="checkbox"/>

**[376] System Test Transmissions/Communicator Call Directions**

Option 1 First Telephone Number (Default ON)	Option 2 Second Telephone Number (Default OFF)	Option 3 Third Telephone Number (Default OFF)	Option 4 Fourth Telephone Number (Default OFF)	Option 5-8 Future Use (Default OFF)
<input checked="" type="checkbox"/>	<input type="checkbox"/>	<input type="checkbox"/>	<input type="checkbox"/>	<input type="checkbox"/>

**[377] Communication Variables**

Default	CE	CP-01		
Default	Default	Default		
003		002	<input type="checkbox"/> <input type="checkbox"/> <input type="checkbox"/> <input type="checkbox"/> <input type="checkbox"/> Swinger Shutdown (Alarms and Rest)	001-014 Transmissions (001-006 for CP-01), 000=disabled
003			<input type="checkbox"/> <input type="checkbox"/> <input type="checkbox"/> <input type="checkbox"/> <input type="checkbox"/> Swinger Shutdown (Tampers and Rest)	001-014 Transmissions (001-006 for CP-01), 000=disabled
003			<input type="checkbox"/> <input type="checkbox"/> <input type="checkbox"/> <input type="checkbox"/> <input type="checkbox"/> Swinger Shutdown (Maint. and Rest)	001-014 Transmissions (001-006 for CP-01), 000=disabled
000		030	<input type="checkbox"/> <input type="checkbox"/> <input type="checkbox"/> <input type="checkbox"/> <input type="checkbox"/> Communication Delay	000-255 seconds
030			<input type="checkbox"/> <input type="checkbox"/> <input type="checkbox"/> <input type="checkbox"/> <input type="checkbox"/> AC Failure Communication Delay	000-255 minutes/hours
010	002		<input type="checkbox"/> <input type="checkbox"/> <input type="checkbox"/> <input type="checkbox"/> <input type="checkbox"/> TLM Trouble Delay	(# of valid checks required 10 x 3s)
030			<input type="checkbox"/> <input type="checkbox"/> <input type="checkbox"/> <input type="checkbox"/> <input type="checkbox"/> Test Transmission Cycle (land line)	001-255 hours/days, 000=disabled
007			<input type="checkbox"/> <input type="checkbox"/> <input type="checkbox"/> <input type="checkbox"/> <input type="checkbox"/> Future Use	Future Use
030			<input type="checkbox"/> <input type="checkbox"/> <input type="checkbox"/> <input type="checkbox"/> <input type="checkbox"/> Delinquency Transmission Delay	001-255 days/hours, 000=disabled
000		005	<input type="checkbox"/> <input type="checkbox"/> <input type="checkbox"/> <input type="checkbox"/> <input type="checkbox"/> Communications Cancelled Window	005-255 minutes (CP-01 Only)

**[378] Test Transmission Time of Day**

Default  
9999      (Valid entries are 0000-2359, 9999 to disable)

**[380] First Communicator Options**

Opt	Def.	ON		OFF
1	<input checked="" type="checkbox"/>	<input type="checkbox"/>	Communications Enabled	<input type="checkbox"/> Communications Disabled
2	<input type="checkbox"/>	<input type="checkbox"/>	Restores on Bell Time-out	<input checked="" type="checkbox"/> Restores Follow Zones
3	<input type="checkbox"/>	<input type="checkbox"/>	Pulse Dialing	<input checked="" type="checkbox"/> DTMF Dialing
4	<input type="checkbox"/>	<input type="checkbox"/>	Switch to Pulse Dialing after 4 Attempts	<input checked="" type="checkbox"/> DTMF Dial for all Attempts
5	<input type="checkbox"/>	<input type="checkbox"/>	For Future Use	<input checked="" type="checkbox"/>
6	<input type="checkbox"/>	<input type="checkbox"/>	Alternating Backup Dialing Enabled	<input checked="" type="checkbox"/> Call Primary Number, Backup to Secondary
7	<input type="checkbox"/>	<input type="checkbox"/>	For Future Use	<input checked="" type="checkbox"/>
8	<input type="checkbox"/>	<input type="checkbox"/>	Delinquency Follows Zone Activity (Hours)	<input checked="" type="checkbox"/> Delinquency Follows Arming (Days)

**[381] Second Communicator Options**

Opt.	Def.	ON	OFF
1	<input type="checkbox"/>	Opening After Alarm Keypad Ringback Enabled	✓ <input type="checkbox"/> Opening After Alarm Ringback Disabled
2	<input type="checkbox"/>	For Future Use	✓ <input type="checkbox"/>
3	<input type="checkbox"/>	SIA Sends Programmed Reporting Codes	✓ <input type="checkbox"/> SIA Sends Automatic Reporting Codes
4	<input type="checkbox"/>	Closing Confirmation Enabled	✓ <input type="checkbox"/> Closing Confirmation Disabled
5-6	<input type="checkbox"/>	For Future Use	✓ <input type="checkbox"/>
7	<input type="checkbox"/>	Contact ID Uses Programmed Reporting Codes	✓ <input type="checkbox"/> Contact ID Uses Automatic Reporting Codes
8	<input type="checkbox"/>	For Future Use	✓ <input type="checkbox"/>

**[382] Third Communicator Options**

Opt.	Def.	ON	OFF
1	<input type="checkbox"/>	For Future Use	✓
2	<input type="checkbox"/>	Alarm Communications Enabled During Walk Test	✓ <input type="checkbox"/> Alarm Communications Disabled During Walk Test
3	<input type="checkbox"/>	Communications Cancelled Message Enabled	✓ <input type="checkbox"/> Communications Cancelled Message Disabled
4	<input type="checkbox"/>	Call Waiting Cancel Enabled	✓ <input type="checkbox"/> Call Waiting Cancel Disabled
5	<input type="checkbox"/>	For Future Use	✓ <input type="checkbox"/> For Future Use
6	<input type="checkbox"/>	AC Failure Communications Delay is in Hours	✓ <input type="checkbox"/> AC Failure Communications Delay is in Minutes
7	<input type="checkbox"/>	Number of Dialing Attempts for Residential Dial is 1	✓ <input type="checkbox"/> Number of Dialing Attempts for Residential Dial is 5
8	<input type="checkbox"/>	For Future Use	✓ <input type="checkbox"/>

**[383] Fourth Communicator Options**

Opt.	Def.	ON	OFF
1	<input type="checkbox"/>	For Future Use	✓ <input type="checkbox"/>
2	<input type="checkbox"/>	Phone Number 2 Backs up PH#1	✓ <input type="checkbox"/> Phone Number 2 is Dedicated
3	<input type="checkbox"/>	Phone Number 3 Backs up PH#2	✓ <input type="checkbox"/> Phone Number 3 is Dedicated
4	<input type="checkbox"/>	Phone Number 4 Backs up PH#3	✓ <input type="checkbox"/> Phone Number 4 is Dedicated
5	✓ <input type="checkbox"/>	FTC Events Communicate	<input type="checkbox"/> FTC Events Do Not Communicate
6	<input type="checkbox"/>	For Future Use	✓ <input type="checkbox"/>
7	<input type="checkbox"/>	For Future Use	✓ <input type="checkbox"/>
8	<input type="checkbox"/>	For Future Use	✓ <input type="checkbox"/>

**DLS Downloading****[401] Downloading Option Codes**

Opt.	Def.	ON	OFF
1	<input type="checkbox"/>	Answering Machine/Double Call Enabled	✓ <input type="checkbox"/> Answering Machine/Double Call Disabled
2	✓ <input type="checkbox"/>	User Can Enable DLS Window	<input type="checkbox"/> User Cannot Enable DLS Window
3	<input type="checkbox"/>	Call-Back Enabled	✓ <input type="checkbox"/> Call-Back Disabled
4	<input type="checkbox"/>	User Initiated Call-Up Enabled	✓ <input type="checkbox"/> User Initiated Call-Up Disabled
5	<input type="checkbox"/>	Auto Event Buffer Upload Enabled	✓ <input type="checkbox"/> Auto Event Buffer Upload Disabled
6	<input type="checkbox"/>	300 Baud Panel Call-Up	✓ <input type="checkbox"/> 110 Baud Panel Call-Up
7	<input type="checkbox"/>	For Future Use	✓ <input type="checkbox"/>
8	<input type="checkbox"/>	For Future Use	✓ <input type="checkbox"/>

**[402] DLS Downloading Computer's Telephone Number (32 Digits)**

**D** | | | | | | | | | | | | | | | | | | | | | | | | | | | | | | | | | | | | | | | | | | | | |

**[403] DLS Downloading Access Code / Panel ID Code (Enter 6 Hexadecimal Digits)**

|\_|\_|\_|\_|\_|\_|\_| Default = 140400

**[404] Panel ID Code (Enter 6 Hexadecimal Digits)**

|\_|\_|\_|\_|\_|\_|\_| Default = 140400

**[405] Answering Machine Double-Call Timer**

Default 060 |\_|\_|\_|\_|\_|\_|\_| Valid entries are 000-255 seconds

**[406] Number of Rings To Answer On**

Default 000 |\_|\_|\_|\_|\_|\_|\_| Valid entries are 000-255 rings

**[501]-[514] PGM Output Attributes**

Program only the following attributes for the PGM options listed. All others are ignored.

<b>Main board</b>		
[501]	PGM 1	_ _ _ _ _ _ _
[502]	PGM 2	_ _ _ _ _ _ _
<b>PC5208</b>		
[503]	PGM 3	_ _ _ _ _ _ _
[504]	PGM 4	_ _ _ _ _ _ _
[505]	PGM 5	_ _ _ _ _ _ _
[506]	PGM 6	_ _ _ _ _ _ _
[507]	PGM 7	_ _ _ _ _ _ _
[508]	PGM 8	_ _ _ _ _ _ _
[509]	PGM 9	_ _ _ _ _ _ _
[510]	PGM 10	_ _ _ _ _ _ _
<b>PC5204</b>		
[511]	PGM 11	_ _ _ _ _ _ _
[512]	PGM 12	_ _ _ _ _ _ _
[513]	PGM 13	_ _ _ _ _ _ _
[514]	PGM 14	_ _ _ _ _ _ _

PGM Option	✓ =ON OFF	1 Not Used -	2 Not Used -	3 True Output Inverted	4 Follows Timer ON/OFF	5 Code Req. No Code	6 Not Used No	7 Not Used No	8 Not Used No
<b>Attribute:</b>									
00	Null PGM (Not Used)								
01	Burglary and Fire Siren Output			✓					
02	Not Used								
03	Sensor Reset (*72)			✓					
04	2-Wire Smoke Support (PGM 2 Only)			✓					
05	Armed Status			✓					
06	Ready To Arm			✓					
07	Keypad Buzzer Follow			✓					
08	Courtesy Pulse			✓					
11	System Tamper			✓					
12	TLM and Alarm			✓					
13	Kiss-off Output			✓					
14	Ground Start Pulse			✓					
15	Remote Operation			✓					
16	Not Used								
17	Away Armed Status			✓					
18	Stay Armed Status			✓					
19	Command Output #1 [*][7][1]			✓	✓	✓			
20	Command Output #2 [*][7][2]			✓	✓				

PGM Option	✓ =ON OFF	1 Not Used -	2 Not Used -	3 True Output Inverted	4 Follows Timer ON/OFF	5 Code Req. No Code	6 Not Used No	7 Not Used No	8 Not Used No
21	Command Output #3 [*][7][3]			✓	✓				
22	Command Output #4 [*][7][4]			✓	✓				
23	For Future Use								
24	For Future Use								
25	Delayed Burglary and Fire Bell Output			✓					
26	Battery Test Output			✓					
27	Police Code			✓					
28	For Future Use								
29	Zone Follower			✓					
30	Status Alarm Memory			✓					
		<b>Notes:</b>		A change of default setting will NOT affect the output.					
				A change of default setting will affect the output.					

Attribute:	1	2	3	4	5	6	7	8
<b>ON</b> <b>OFF</b>	Service Req. Event	AC Fail	TLM Fault	FTC Enabled	Device Fault	Device Tamper	Device Low Battery	Loss of Clock
	Disabled	Disabled	Disabled	Disabled	Disabled	Disabled	Disabled	Disabled
<b>09 System Trouble</b>	✓	✓	✓	✓	✓	✓	✓	✓

Attribute:	1	2	3	4	5	6	7	8
<b>ON</b> <b>OFF</b>	Burglary Event	Fire Event	Panic Event	Medical Event	Supervisory Event	Priority Event	Duress Event	Output Follows Timer
	Disabled	Disabled	Disabled	Disabled	Disabled	Disabled	Disabled	Disabled
<b>10 System Event</b>	✓	✓	✓	✓	✓	✓	✓	
<b>Note:</b> If a System Event PGM is programmed to follow the Command Output Timer, attribute 8 must be enabled.								

Location	PGM 29 Zone Follower	
	Option On	Option Off
Option 1	For Future Use	
Option 2	For Future Use	
Option 3	True Output	Inverted
Option 4	For Future Use	
Option 5	For Future Use	
Option 6	For Future Use	
Option 7	For Future Use	
Option 8	AND Logic	Or Logic

Zone Follower PGM requires 2 programming sections for attributes: the normal PGM attribute Sections [501-514] and Sections [551-564] for zone assignment.

**[551]-[564] PGM Zone Assignment**

Section Number	Output Number	Zone Follower Zone							
		1	2	3	4	5	6	7	8
Main Board									
[551]	PGM 1								
[552]	PGM 2								
PC5208									
[553]	PGM 3								
[554]	PGM 4								
[555]	PGM 5								
[556]	PGM 6								

Section Number	Output Number	Zone Follower Zone							
[557]	PGM 7								
[558]	PGM 8								
[559]	PGM 9								
[560]	PGM 10								
PC5204									
[561]	PGM 11								
[562]	PGM 12								
[563]	PGM 13								
[564]	PGM 14								

**[601] Closing (Arming) Reporting Codes, Access Codes 33-40**

Code 33    Code 34    Code 35    Code 36    Code 37    Code 38    Code 39    Code 40  
                                  

**[605] Opening (Disarming) Reporting Codes, Access Codes 33-40**

Code 33    Code 34    Code 35    Code 36    Code 37    Code 38    Code 39    Code 40  
                                  

**INTERNATIONAL PROGRAMMING**

**[700] Automatic Clock Adjustment**

Default = 60   Valid Entries 00-99 Seconds

**[701] First International Options**

Note: Programming options indicated in grey are CE defaults.

- | Opt | Def.                                | ON   |                                     | OFF   |
|-----|-------------------------------------|--|-------------------------------------|---|
| 1   | <input checked="" type="checkbox"/> | <input type="checkbox"/> 50 Hz AC                                  | <input checked="" type="checkbox"/> | <input type="checkbox"/> 60 Hz AC                         |
| 2   | <input type="checkbox"/>            | <input type="checkbox"/> Time Base - Internal Crystal              | <input checked="" type="checkbox"/> | <input type="checkbox"/> Time Base - AC Line              |
| 3   | <input type="checkbox"/>            | <input type="checkbox"/> AC/DC Arming Inhibit Enabled              | <input checked="" type="checkbox"/> | <input type="checkbox"/> AC/DC Arming Inhibit Disabled    |
| 4   | <input type="checkbox"/>            | <input type="checkbox"/> All System Tamper Require Installer Reset | <input checked="" type="checkbox"/> | <input type="checkbox"/> All System Tamper Follow Restore |
| 5   | <input type="checkbox"/>            | <input type="checkbox"/> 6-digit User Access Codes                 | <input checked="" type="checkbox"/> | <input type="checkbox"/> 4-digit User Access Codes        |
| 6   | <input type="checkbox"/>            | <input type="checkbox"/> Busy Tone Detection Enabled               | <input checked="" type="checkbox"/> | <input type="checkbox"/> Busy Tone Detection Disabled     |
| 7-8 | <input type="checkbox"/>            | <input type="checkbox"/> For Future Use                            | <input checked="" type="checkbox"/> | <input type="checkbox"/>                                  |

**[702] Second International Options**

- | Opt | Def.                                | ON   |                                     | OFF  |
|-----|-------------------------------------|--|-------------------------------------|--|
| 1   | <input type="checkbox"/>            | <input type="checkbox"/> Pulse Dialing Make/Break Ratio is 33/67 | <input checked="" type="checkbox"/> | <input type="checkbox"/> Pulse Dialing Make/Break Ratio is 40/60 |
| 2   | <input checked="" type="checkbox"/> | <input type="checkbox"/> Force Dialing Enabled                   | <input type="checkbox"/>            | <input type="checkbox"/> Force Dialing Disabled                  |
| 3   | <input type="checkbox"/>            | <input type="checkbox"/> For Future Use                          | <input checked="" type="checkbox"/> | <input type="checkbox"/>   |
| 4   | <input type="checkbox"/>            | <input type="checkbox"/> 1600Hz Handshake                        | <input checked="" type="checkbox"/> | <input type="checkbox"/> Standard Handshake                      |
| 5   | <input type="checkbox"/>            | <input type="checkbox"/> ID Tone Enabled                         | <input checked="" type="checkbox"/> | <input type="checkbox"/> ID Tone Disabled                        |
| 6   | <input type="checkbox"/>            | <input type="checkbox"/> 2100 Hz ID Tone                         | <input checked="" type="checkbox"/> | <input type="checkbox"/> 1300 Hz ID Tone                         |
| 7   | <input type="checkbox"/>            | <input type="checkbox"/> One-Time 1-Hour DLS Window              | <input checked="" type="checkbox"/> | <input type="checkbox"/> 6-Hour DLS Window                       |
| 8   | <input type="checkbox"/>            | <input type="checkbox"/> For Future Use                          | <input checked="" type="checkbox"/> | <input type="checkbox"/>   |

**[703] Delay Between Dialing Attempts**

Default = 003   Valid entries are 000-255 seconds (entry + 5 seconds)

**[900] Panel Version**

Not Programmable

**[901] Installer Walk Test Mode Enable/Disable**

See [901] Installer Walk Test Mode Enable/Disable.

**[902] Module Supervision Reset**

See [902] Module Supervision Reset.

**[903] View Module Supervision**

See [903] View Module Supervision.

**[990] Installer Lockout Enable**

Enter [990] [Installer's Code] [990]

**[991] Installer Lockout Disable**

Enter [991] [Installer's Code] [991]

**[999] Restore Panel Factory Defaults**

Enter [999] [Installer's Code] [999]



## 6 Testing & Troubleshooting

### Testing:

- Power up system
- Program options as required (see Section 5 Programming Worksheets)
- Violate, then restore zones
- Verify correct **Reporting Codes** are sent to the central station

### Troubleshooting:

- Power up system
- Enter [\*][2] to view **Troubles**
- Perform actions indicated in the tables below

### Trouble Summary:

Trouble [1] Service Required - Press [1] or \* for more information:

- 1 - Low Battery
- 2 - Bell Circuit Trouble
- 3 - General System Trouble
- 4 - General System Tamper
- 5 - General System Supervisory
- 6 - Not Used
- 7 - PC5204 Low Battery
- 8 - PC5204 AC Fail

Trouble [2] - AC Trouble

Trouble [3] - Telephone Line Trouble

Trouble [4] - Failure to Communicate

Trouble [5] - Zone Fault - Press [5] or \* for more information

Trouble [6] - Zone Tamper - Press [6] or \* for more information

Trouble [7] - Not Used

Trouble [8] - Loss of Time or Date - Press \* to program date and time

Trouble	Cause	Troubleshooting
<b>Trouble [1] Service Required</b>		<b>Press [1] to determine specific trouble</b>
[1] Low Battery	Main panel battery less than 11.1 VDC  <b>Note:</b> This trouble condition will not clear until the battery voltage is 12.5 VDC min., under load.	<b>Note:</b> If battery is new, allow 1 hour for battery to charge. Verify voltage measured across AC terminals is 16-18 VAC. -Replace transformer if required. Disconnect battery wire leads. • Verify battery charging voltage measured across battery leads = 13.70 - 13.80 VDC. Connect battery, remove AC power. • Verify measured voltage across battery terminals is 12.5 VDC min.
[2] Bell Circuit	Bell+, Bell-...Open Circuit	Disconnect Bell-/Bell+ wire leads, measure resistance of wire leads. • Open circuit indicates break in wiring or defective siren/bell. Jumper Bell+, Bell- with 1K resistor (Brown, Black, Red) • Verify trouble clears.
[3] General System Trouble	PC5204 Output #1 Open Circuit	If Output #1 is unused: • Ensure that terminals O1, AUX are jumpered with 1K resistor (Brown, Black, Red). If Output #1 is used: • Disconnect wire leads from O1, AUX terminals, measure the resistance of the wire leads. Open circuit indicates a break in the wiring.

Trouble	Cause	Troubleshooting
	PC520X Aux Power Supply Trouble	<ul style="list-style-type: none"> <li>Ensure that a the power supply aux power terminal is not shorted to ground.</li> <li>Ensure that the maximum power supply aux current has not been exceeded.</li> </ul>
[4] General System Tamper	Tamper input on module(s) open circuit	Short tamper terminal to COM terminal on unused modules connected to KEYBUS (PC5200, PC5204, PC5208, PC5601).
[5] Module Supervision	Panel does not communicate with module(s) on KEYBUS  Keypad assigned to incorrect slot	<p>Modules are immediately enrolled and supervised when detected on the KEYBUS. If a module has been removed, or if the slot assignment of a keypad has been changed, module supervision must be reset.</p> <ul style="list-style-type: none"> <li>View the event buffer (via DLS or LCD5500 keypad) to identify the specific modules in trouble.</li> <li>To reset module supervision: <ul style="list-style-type: none"> <li>-Enter Programming Section [902].</li> <li>-Press [#] (wait 1 minute for panel to scan KEYBUS).</li> </ul> </li> <li>Enter Programming Section [903] to identify modules connected to the KEYBUS.</li> </ul>
[6] Not Used		
[7] PC520X Low Battery	PC520X battery less than 11.5VDC <b>Note:</b> This trouble condition will not clear until the battery voltage is 12.5VDC min., under load.	See [1] Low Battery above.
[8] PC520X AC Failure	No AC at PC5204 AC inputs	Verify voltage measured across AC terminals is 16-18VAC. Replace transformer if required.

**Trouble [2] AC Failure**

AC Failure	No AC at panel AC input terminals.	<ul style="list-style-type: none"> <li>Verify voltage measured across AC terminals is 16-18VAC. Replace transformer if required.</li> </ul>
------------	------------------------------------	---

**Trouble [3] Telephone Line Trouble**

Telephone Line Trouble	Phone line voltage at TIP, RING on main panel is less than 3VDC.	<p>Measure the voltage across TIP and RING on the panel:</p> <ul style="list-style-type: none"> <li>No phone off-hook – 50VDC (approx.)</li> <li>Any phone off-hook – 5VDC (approx.)</li> </ul> <p>Wire incoming line directly to TIP and RING.</p> <ul style="list-style-type: none"> <li>If trouble clears, check wiring or the RJ-31x phone jack.</li> </ul>
------------------------	--	---

**Trouble [4] Failure to Communicate**

Failure to Communicate	Panel fails to communicate one or more events to central station.	<p>Connect a handset to TIP and RING of the control panel. Monitor for the following conditions:</p> <p><b>Continuous dial tone</b></p> <ul style="list-style-type: none"> <li>Reverse TIP and RING.</li> </ul> <p><b>Recorded operator message comes on</b></p> <ul style="list-style-type: none"> <li>Verify correct phone number is programmed.</li> <li>Dial the number programmed using a regular telephone to determine if a [9] must be dialed or if 800 service is blocked.</li> </ul> <p><b>Panel does not respond to handshakes</b></p> <ul style="list-style-type: none"> <li>Verify the format programmed is supported by the central station.</li> </ul> <p><b>Panel transmits data multiple times without receiving a handshake</b></p> <ul style="list-style-type: none"> <li>Verify that the account number and reporting codes are correctly programmed.</li> </ul> <p><b>Contact ID and Pulse formats</b></p> <ul style="list-style-type: none"> <li>Program a HEX [A] to transmit a digit [0].</li> </ul> <p><b>SIA format</b></p> <ul style="list-style-type: none"> <li>Program a digit [0] to transmit a digit [0].</li> </ul>
------------------------	---	--

Trouble	Cause	Troubleshooting
---------	-------	-----------------

<b>Trouble [5] Zone Fault      Press [5] to determine specific zones with a Fault trouble</b>		
	Open circuit is present on one or more fire zones on the main panel or zone expander	<ul style="list-style-type: none"> <li>• Ensure fire zones have a 5.6K resistor (Green, Blue, Red) connected.</li> <li>• Remove the wire leads from Z and COM terminals and measure the resistance of the wire leads. - An open circuit indicates a break in the wiring or resistor not connected.</li> <li>• Connect a 5.6K resistor (Green, Blue, Red) across the Z and COM terminals. Verify the trouble condition clears.</li> </ul>
	An open circuit is present on PGM 2 being used as a 2-wire smoke detector input	<ul style="list-style-type: none"> <li>• Ensure the correct 2.2K end-of-line resistor is connected (Red, Red, Red).</li> <li>• Remove the wire leads from PGM2 and AUX+ terminals and measure the resistance of the wire leads. - An open circuit indicates a break in the wiring or no resistor connected.</li> <li>• Connect a 2.2K resistor (Red, Red, Red) across the PGM 2 and AUX+ terminals. Verify the trouble condition clears.</li> </ul>
	A short circuit is present on one or more zones with double end-of-line resistors enabled	<ul style="list-style-type: none"> <li>• Remove the wire leads from Z and COM terminals and measure the resistance of the wire leads. - A short circuit indicates a short in the wiring.</li> <li>• Connect a 5.6K resistor (Green, Blue, Red) across the Z and COM terminals. - Verify the trouble condition clears.</li> </ul>

<b>Trouble [6] Zone Tamper      Press [6] to determine specific zones with a tamper trouble</b>		
	An open circuit is present on one or more zones with double end-of-line resistors enabled.	<ul style="list-style-type: none"> <li>• Remove the wire leads from Z and COM terminals.</li> <li>• Measure the resistance of the wire leads. -Open circuit indicates a break in the wiring.</li> <li>• Connect a 5.6K resistor (Green, Blue, Red) across the Z and COM terminals.</li> <li>• Verify the trouble condition clears.</li> </ul>

**Trouble [7] Not Used**

**Trouble [8] Loss of Clock/Date**

Loss of time and date	The main panel internal clock is not set.	<p>To program the time and date:</p> <ul style="list-style-type: none"> <li>• Enter [*][6][Master Code] then Press [1].</li> <li>• Enter the time and date (in military) using the following format: <b>HH:MM MM/DD/YY</b></li> </ul> <p><b>Example.</b></p> <p style="padding-left: 20px;">For 6:00 pm, Nov. 30, 2007</p> <p><b>Enter:</b> [18] [00] [11] [30] [07]</p>
-----------------------	---	--

## Appendix A: Reporting Code Formats

The following tables contain Contact ID and Automatic SIA format reporting codes. See Programming Sections [320]-[348] for Reporting Codes.

### Contact ID

The first digit (in parentheses) is automatically sent by the control. The second two digits are programmed to indicate specific information about the signal. For example, if zone 1 is an entry/exit point, you could program the event code as [34]. The central station would receive the following:

\*BURG - ENTRY/EXIT - 1 where the "1" indicates which zone went into alarm.

### SIA Format - Level 2 (Hard Coded)

The SIA communication format used in this product follows the level 2 specifications of the SIA Digital Communication Standard-October 1997. This format will send the Account Code along with its data transmission. The transmission will look similar to the following at the receiver:

**Note:** A system event will use the Area Identifier ri00.

**N ri1= BA 01**

N = New Event

ri1 = Partition /Area Identifier

BA= Burglary Alarm

01= Zone 1

**Table 1: Reporting Codes**

Section #	Reporting Code	Code Sent When...	Dialer Direction*	Automatic Contact ID Codes	SIA Auto Rep Codes**
[320]	Zone Alarms	Zone goes into alarm	A/R		
[324]	Zone Restores	Alarm condition has been restored	A/R		See the tables on next page for details
[328]	Duress Alarm	Duress code entered at keypad	A/R	E(1)21-000	HA-00
[328]	Opening After Alarm	System disarmed with alarm in memory	A/R	E(4) 58-UUU	OR-UU
[328]	Recent Closing	Alarm occurs within two minutes of system arming	A/R	E(4)59-UUU	CR-UU
[328]	Zone Expander Supervisory Alarm/Rest.	Panel loses/restores supervisory transmission over the Keybus from zone expansion modules or keypads with zone inputs	A/R	E(1)43-000/ R(1) 43-000	UA-00/ UH-00
[328]	Cross Zone (Police Code) Alarm	Two zones on the same partition go into alarm during any given armed-to-armed period (incl. 24Hr zones)	A/R	E(1)39-000	BM-00/BV-00
[328]	Alarm Cancelled	Sent when the system is disarmed after an alarm, but before the expiry of the alarm cancellation timer.	A/R	E(4)A6-UUU	OC-UU
[329]	[F] Key Alarm/Rest.	Keypad fire alarm (alarm and restore rep. codes sent together)	A/R	E(1)1A-000/ R(1)1A-000/	FA-00/FH-00
[329]	[A] Key Alarm/Rest.	Keypad auxiliary alarm (alarm and restore rep. codes sent together)	A/R	E(1)AA-000/ R(1)AA-000/	MA-00/MH-00
[329]	[P] Key Alarm/Rest.	Keypad panic alarm (alarm and restore rep. codes sent together)	A/R	E(1)2A-000/ R(1)2A-000	PA-00/PH-00
[329]	Auxiliary Input Alarm/Rest.	Option#23-24: a panic button wired to PGM 2 is pressed/ access code is entered. Option #04: a 2-wire smoke detector wired to PGM 2 goes into alarm/alarm is cleared.	A/R	E(1)4A-000/ R(1)4A-000 E(1)11-000/ R(1)11-000	UA-99/UH-99 FA-99/FH-99
[330], [334]	Zone Tamper/Restore	Zone is tampered / tamper condition restored	T/R	E(3)83-ZZZ/ R(3)83-ZZZ/	TA-ZZ/TR-ZZ
[338]	General System Tamper/Rest.	Case/cover has a tamper alarm. Case/cover tamper restored	T/R	E(1)45-000/ R(1)45-000	ES-00/EJ-00
[338]	Keypad Lockout	Maximum number of incorrect access codes has been entered at a keypad	T/R	E(4)61-000	JA-00
[339-341], [601]	Closings	System armed (user 01-39, 40 indicated)	O/C	R(4)A1-UUU	CL-UU
[341]	Automatic Zone Bypass	A zone was bypassed at the time of arming	O/C	E(5)7A-ZZZ	UB-ZZ
[341]	Partial Closing	One or more zones bypassed when system armed	O/C	E(4)56-000	CG-00
[341]	Special Closing	Closing (arming) using one of the following methods: quick arm, keyswitch, function key, maintenance code, DLS software	O/C	R(4)AA-000	CL-00
[341]	Late to Close	Whenever the Auto-arm pre-alert sounds (if the Late to Close option is enabled)	O/C	R(4)54-000	CI-00
[341]	Exit Fault	Sent when an exit error occurs and the Entry Delay expires before the system is disarmed	O/C	E(3)74-ZZZ	EA-ZZ
[342-344], [605]	Openings	System disarmed (user 01-39, 40 indicated)	O/C	E(4)A1-UUU	OP-UU
[344]	Special Opening	Opening (disarming) using one of the following methods: keyswitch, maintenance code, DLS software	O/C	E(4)AA-000	OP-00
[345]-[346]	Battery Trouble/Rest.	PC1404 System battery is low/battery restored.	MA/R	E(3)A2-000/ R(3)A2-000	YT-00/YR-00

**Table 1: Reporting Codes**

Section #	Reporting Code	Code Sent When...	Dialer Direction*	Automatic Contact ID Codes	SIA Auto Rep Codes**
[345]-[346]	AC Line Trouble/Rest.	AC power to control panel is disconnected or interrupted/AC power restored (Both codes follow AC Failure Comm. Delay.)	MA/R	E(3)A1-000/ R(3)A1-000	AT-00/AR-00
[345]-[346]	Bell Circuit Trouble/Rest.	Software deactivates the bell output if a short is detected so no additional current is taken from the battery./Bell output restored.	MA/R	E(3)21-000/	YA-99/YH-99
[345]-[346]	Fire Trouble/Rest. 2-wire Smoke Trouble/Rest.	Trouble occurs/restore on a fire zone Trouble occurs/restore on 2-wire smoke detector zone	MA/R	E(3)73-000/ R(3)73-000	FT-00/FJ-00 FT/FJ-99
[345]-[346]	Auxiliary Power Trouble/Rest.	Aux voltage supply trouble/restore	MA/R	E(3)12-000/ R(3)12-000	YP-00/YQ-00
[346]	TLM Restore	Telephone line restored	MA/R	E(3)51-000	LR-01
[345]-[346]	Gen. System Trouble/Rest.	"Service Required" trouble occurs (view troubles using [*][2])/trouble restored	MA/R	E(3)AA-000	YX-00/YZ-00
[345]-[346]	Gen. System Supervisory Trouble/Rest.	Control panel has detected an alternate communicator fault/communications restored.	MA/R	E(3)3A-000	ET-00/ER-00
[346]	Cold Start	The PC1404 has restarted after total power loss.	MA/R	R(3)A5-000	RR-00
[347]	Phone 1-4 FTC Restore	Control panel has restored communications to central station on Phone 1, 2, 3 or 4 (after FTC)	MA/R	R(3)54-000	YK-00
[347]	Event Buffer is 75% Full	Event buffer is almost full since last upload	MA/R	E(6)22-000	JL-00
[347]	DLS Lead In	Downloading session start	MA/R	E(4)11-000	RB-00
[347]	DLS Lead Out	Downloading session complete	MA/R	E(4)12-000	RS-00
[347]	Zone Fault/Rest.	One or more zones have faults/restored	MA/R	E(3)8A-ZZZ/ R(3)8A-ZZZ/	UT-ZZ/UJ-ZZ
[347]	Delinquency	Programmed amount of time (days or hours) for delinquency has expired without zone activity, or without system being armed	MA/R	E(6)54-000***	CD-00
[347]	Installer Lead In	Installer's mode has been entered	MA/R	E(6)27-000	LB-00
[347]	Installer Lead Out	Installer's mode has been exited	MA/R	E(6)28-000	LS-00
[348]	Walk Test End	End of test	T	R(6)A7-UUU	TE-UU
[348]	Walk Test Begin	Beginning of test	T	E(6)A7-UUU	TS-UU
[348]	Periodic Test	Periodic system test transmission	T	E(6)A2-000	RP-00
[348]	System Test	[*][6] bell/communications test	T	E(6)A1-000	RX-00
*	A/R = alarms/restores; T/R = tampers/restores; O/C = openings/closings; MA/R = miscellaneous alarms/restores; T = test transmissions				
**	UU = user number (user 01-39, 40); ZZ = zone number (01-08).				
***	Use the "Fail to close" event code [(4)54] to report closing or activity delinquency. Ensure the central station is aware that this code is used.				

**Table 2: Contact ID Programmed Zone Alarm/Restoral Event Codes**

(as per SIA DCS: 'Contact ID' 01-1999): Program any of these codes for zone alarms/restores when using the standard (non-automatic) Contact ID reporting format.

<b>Medical Alarms</b>	(1)34 Entry / Exit
(1)AA Medical	(1)35 Day / Night
(1)A1 Pendant Transmitter	(1)36 Outdoor
(1)A2 Fail to Report In	(1)37 Tamper
<b>Fire Alarms</b>	(1)38 Near Alarm
(1)1A Fire Alarm	<b>General Alarms</b>
(1)11 Smoke	(1)4A General Alarm
(1)12 Combustion	(1)43 Exp. Module Failure
(1)13 Water Flow	(1)44 Sensor Tamper
(1)14 Heat	(1)45 Module Tamper
(1)15 Pull Station	(1)4A Cross Zone Police Code
(1)16 Duct	<b>24 Hour Non-Burglary</b>
(1)17 Flame	(1)5A 24 Hour non-Burg
(1)18 Near Alarm	(1)51 Gas Detected
<b>Panic Alarms</b>	(1)52 Refrigeration
(1)2A Panic	(1)53 Loss of Heat
(1)21 Duress	(1)54 Water Leakage
(1)22 Silent	(1)55 Foil Break
(1)23 Audible	(1)56 Day Trouble
<b>Burglar Alarms</b>	(1)57 Low Bottled Gas Level
(1)3A Burglary	(1)58 High Temp
(1)31 Perimeter	(1)59 Low Temp

**Table 3: Automatic Zone Alarm/Restoral Codes**

Zone Definition	SIA Auto Rep Codes*	Contact ID Auto Rep Codes*	Contact ID Rest. Auto Rep Codes
Delay 1	BA-ZZ/BH-ZZ	E(1)3A-ZZZ	E(1)3A-ZZZ
Delay 2	BA-ZZ/BH-ZZ	E(1)3A-ZZZ	E(1)3A-ZZZ
Instant	BA-ZZ/BH-ZZ	E(1)3A-ZZZ	E(1)3A-ZZZ
Interior	BA-ZZ/BH-ZZ	E(1)3A-ZZZ	E(1)3A-ZZZ
Interior Stay/Away	BA-ZZ/BH-ZZ	E(1)3A-ZZZ	E(1)3A-ZZZ
Delay Stay/Away	BA-ZZ/BH-ZZ	E(1)3A-ZZZ	E(1)3A-ZZZ
Delayed 24 Hr Fire	FA-ZZ/FH-ZZ	E(1)1A-ZZZ	R(1)1A-ZZZ
Standard 24 Hr Fire	FA-ZZ/FH-ZZ	E(1)1A-ZZZ	R(1)1A-ZZZ
Auto-Verified Fire	FA-ZZ / FH-ZZ	E(1)1A-ZZZ	R(1)1A-ZZZ
24-Hr. Supervisory	US-ZZ/UR-ZZ	E(1)5A-ZZZ	E(1)5A-ZZZ
24-Hr. Supervisory Buzzer	UA-ZZ/UH-ZZ	E(1)4A-ZZZ	E(1)4A-ZZZ
24-Hr. Burg	BA-ZZ/BH-ZZ	E(1)3A-ZZZ	E(1)3A-ZZZ
24-Hr. Gas	GA-ZZ/GH-ZZ	E(1)51-ZZZ	E(1)51-ZZZ
24-Hr. Heat	KA-ZZ/KH-ZZ	E(1)58-ZZZ	E(1)58-ZZZ
24-Hr. Medical	MA-ZZ/MH-ZZ	E(1)AA-ZZZ	E(1)AA-ZZZ
24-Hr. Panic	PA-ZZ/PH-ZZ	E(1)2A-ZZZ	E(1)2A-ZZZ
24-Hr. Emergency	QA-ZZ/QH-ZZ	E(1)A1-ZZZ	E(1)A1-ZZZ
24-Hr. Water	WA-ZZ/WH-ZZ	E(1)54-ZZZ	E(1)54-ZZZ
24-Hr. Freeze	ZA-ZZ/ZH-ZZ	E(1)59-ZZZ	E(1)59-ZZZ
24-Hr. Latching Tamper	UA-ZZ/UH-ZZ	E(1)4A-ZZZ	R(1)4A-ZZZ
Interior Delay	BA-ZZ/BH-ZZ	E(1)3A-ZZZ	E(1)3A-ZZZ
Instant Stay/Away	BA-ZZ/BH-ZZ	E(1)3A-ZZZ	E(1)3A-ZZZ
24-Hr. Bell/Buzzer	UA-ZZ/UH-ZZ	E(1)5A-ZZZ	R(1)5A-ZZZ
24-Hr. Non-latching Tamper	TA-ZZ/TR-ZZ	E(3)83-ZZZ	E(3)83-ZZZ
Day Zone	BA-ZZ/BH-ZZ	E(1)3A-ZZZ	E(1)3A-ZZZ
Night Zone	BA-ZZ/BH-ZZ	E(3)83-ZZZ	E(3)83-ZZZ
24-Hr. CO Alarm	GA-ZZ/GH-ZZ	E(1)62-ZZZ	E(1)62-ZZZ
* ZZ = zones 01-08			

## Appendix B: Communicator Format Options

The following format options are programmable in Section [350] Communicator Format Options

- 01 20 BPS, 1400 Hz handshake**  
**02 20 BPS, 2300 Hz handshake**

- BPS Formats - 0 is not valid in Account or Rep Code (A must be used).

Depending on the pulse format, the panel communicates using the following: 3/1, 3/2, 4/1 or 4/2, 1400 or 2300 Hz handshake, 20 bits per second, non-extended. Digit "0" sends no pulses and is used as a filler. When programming account numbers enter four digits. When programming a three digit account number the fourth digit must be programmed as a "0" which will act as a filler digit. If an account number has a "0" in it, substitute a HEX digit "A" for the "0."

Examples:

- 3 digit account number [123]- program [1230]
- 3 digit account number [502] - program [5A20]
- 4 digit account number [4079] - program [4A79]

Two digits must be entered when programming reporting codes. If one digit reporting codes are used, the second digit must be programmed as "0". If "0" is to be transmitted, substitute a HEX digit "A" for the "0".

Examples:

- 1 digit reporting code [3] - program [30]
- 2 digit reporting code [30] - program [3A]

To prevent the panel from reporting an event, program the reporting code for the event as [00] or [FF].

### 03 DTMF Contact ID

- **ADEMCO Contact ID - 0 is not valid in Account or Rep Code (A must be used, 10 in checksum)**

Contact ID is a specialized format that communicates information quickly using tones rather than pulses. The format also allows more information to be sent. For example, rather than reporting an alarm zone 1, the Contact ID format can also report the type of alarm, such as Entry/Exit alarm zone 1.

If **Contact ID Sends Automatic Reporting Codes** is selected, the panel automatically generates a reporting code for each event. These identifiers are listed in Appendix A. If the Automatic Contact ID option is not selected, reporting codes must be programmed. The 2-digit entry determines the type of alarm. The panel automatically generates all other information, including the zone number.

NOTE:If Automatic Contact ID is selected, the panel automatically generates all zone and access code numbers, eliminating the need to program these items.

NOTE:The zone number for Zone Fault events will not be identified when Pulse formats are used.

If the **Contact ID uses Automatic Reporting Codes** option is enabled, the panel will operate as follows:

- If an event's reporting code is programmed as [00], the panel will not attempt to call the central station.
- If the reporting code for an event is programmed as anything from [01] to [FF], the panel automatically generates the zone or access code number. See Appendix A for a list of transmitted codes.

If the **Contact ID uses Programmed Reporting Codes** option is enabled, the panel will operate as follows:

- If an event's reporting code is programmed as [00] or [FF], the panel will not attempt to call central station.
- If the reporting code for an event is programmed as anything from [01] to [FE], the panel will send the programmed reporting code.

Account numbers must be four digits:

- If the digit "0" is in the account number substitute the HEX digit "A" for the "0."
- All reporting codes must be two digits.
- If the digit "0" is in the reporting code substitute the HEX digit "A" for the "0."

To prevent the panel from reporting an event, program the reporting code for the event as [00] or [FF].

See: Contact ID Sends Automatic Reporting Codes section [381], Option [7]

### 04 SIA FSK

- **SIA -0 is valid in Account or Rep Code (not 00 in a Reporting code)**
- **SIA -0 uses 300 Baud FSK as the communication media. Account Code can be 4 or 6 hexadecimal digits. Reporting codes must be 2 digits. The SIA format transmits a 4 (or 6) digit account code, 2 digit identifier code and 2 digit reporting code. The 2 digit identifier is pre programmed by the panel.**

SIA is a specialized format that communicates information quickly using frequency shift keying (FSK) rather than pulses. The SIA format automatically generates the type of signal being transmitted, such as Burglary, Fire, Panic etc. The two digit reporting code is used to identify the zone or access code number.

If the SIA format is selected the panel can be programmed to automatically generate all zone and access code numbers eliminating the need to program these items.

If the **SIA Sends Automatic Reporting Codes** option is enabled the panel will operate as follows:

1. If the reporting code for an event is programmed as [00] the panel will not attempt to call the central station.
2. If the reporting code for an event is programmed as anything from [01] to [FF] the panel will AUTOMATICALLY generate the zone or access code number.
3. During a partial closing, all bypassed zones are reported.

**Communicator Call Direction Options** can be used to disable reporting of events such as Openings/Closings. Also, if all the Opening/Closing reporting codes were programmed as [00] the panel would not report.

If the **SIA Sends Automatic Reporting Codes** option is disabled the panel operates as follows:

1. If the reporting code for an event is programmed as [00] or [FF] the panel will not attempt to call the central station.
2. If the reporting code for an event is programmed as anything from [01] to [FE] the panel will send the programmed reporting code.
3. During a partial closing, bypassed zones are not reported.

NOTE:The zone number for Zone Fault events will not be identified when Programmed SIA is used.

See: **SIA Sends Automatic Reporting Codes - Section [381], Option [3],**

**Communicator Call Direction Options - Section [351] to [376],**

**SIA Identifiers - Appendix A**

### 06 Residential Dial

If Residential Dial is programmed and an event that is programmed to communicate occurs, the panel will seize the line and dial the appropriate telephone number(s).

Once the dialing is complete, the panel will emit an ID tone and wait for a handshake (press a 1, 2, 4, 5, 7, 8, 0, \* or # key from any telephone). It will wait for this handshake for the duration of **Post Dial Wait for Handshake** timer. Once the panel receives the handshake, it will emit an alarm tone over the telephone line for 20 seconds.

If several alarms occur at the same time, only one call will be made to each telephone number the panel is programmed to call. If a handshake is not desired, turn Section [382] Option 7 ON so that the residential dial only makes one attempt.

- 07 10 BPS, 1400 Hz handshake**  
**08 10 BPS, 2300 Hz handshake**

- BPS Formats - 0 is not valid in Account or Rep Code (A must be used)

Depending on the pulse format, the panel communicates using the following: 3/1, 3/2, 4/1 or 4/2, 1400 or 2300 Hz handshake, 10 or 20 bits per second, non-extended. Digit "0" sends no pulses and is used as a filler. When programming account numbers enter four digits. When programming a three digit account number, the fourth digit must be programmed as a "0" which will act as a filler digit. If an account number has a "0" in it, substitute a HEX digit "A" for the "0."

Examples:

- 3 digit account number [123] - program [1230]
- 3 digit account number [502] - program [5A20]
- 4 digit account number [4079] - program [4A79]

Two digits must be entered when programming reporting codes. If one digit reporting codes are used, the second digit must be programmed as "0". If "0" is to be transmitted, substitute a HEX digit "A" for the "0".

Examples:

- 1 digit reporting code [3] - program [30]
- 2 digit reporting code [30] - program [3A]

To prevent the panel from reporting an event, program the reporting code for the event as [00] or [FF].

## 09 Private Line (Eastern EU)

The private line format allows the communication of zone alarms directly to a user over a telephone line. When an event occurs that the panel is programmed to communicate, the panel seizes the line and dials the programmed telephone number(s). The panel then emits a double beep on the line every 3 seconds, regardless of what is happening on the phone line; it may still be ringing, sounding a busy tone, etc. The double beep indicates to the user receiving the call that the control panel is calling. The user must acknowledge the call by pressing 1, 2, 3, 4, 5, 6, 7, 8, 9, 0, \* or # from any touchtone telephone. The panel will wait for this acknowledgement for the duration of the post dial wait for handshake timer (40 seconds).

The panel will then indicate which zone is in alarm by sounding a corresponding number of beeps (e.g. 3 beeps for zone 3). The user must then press a key to acknowledge the alarm. If the panel has another alarm to communicate, it will sound a corresponding number of beeps for the new zone alarm. The user must then press a key to acknowledge the signal. When there are no further alarms, the panel will hang up.

**Note:** Only alarm events are supported by Private Line. It's likely the panel will be unable to decode DTMF digits from some cell phones, and this feature will not operate correctly as a result.



## Appendix C: Regulatory Approvals Information

### North America

#### FCC COMPLIANCE STATEMENT

**CAUTION: Changes or modifications not expressly approved by Digital Security Controls could void your authority to use this equipment.**

This equipment has been tested and found to comply with the limits for a Class B digital device, pursuant to Part 15 of the FCC Rules. These limits are designed to provide reasonable protection against harmful interference in a residential installation. This equipment generates, uses and can radiate radio frequency energy and, if not installed and used in accordance with the instructions, may cause harmful interference to radio communications. However, there is no guarantee that interference will not occur in a particular installation. If this equipment does cause harmful interference to radio or television reception, which can be determined by turning the equipment off and on, the user is encouraged to try to correct the interference by one or more of the following measures:

- Re-orient the receiving antenna.
- Increase the separation between the equipment and receiver.
- Connect the equipment into an outlet on a circuit different from that to which the receiver is connected.
- Consult the dealer or an experienced radio/television technician for help.

The user may find the following booklet prepared by the FCC useful: "How to Identify and Resolve Radio/Television Interference Problems". This booklet is available from the U.S. Government Printing Office, Washington D.C. 20402, Stock # 004-000-00345-4.

#### IMPORTANT INFORMATION

This equipment complies with Part 68 of the FCC Rules and, if the product was approved July 23, 2001 or later, the requirements adopted by the ACTA. On the side of this equipment is a label that contains, among other information, a product identifier. If requested, this number must be provided to the Telephone Company.

**Product Identifier** US:F53AL01BPC1404 USOC Jack:RJ-31X

#### Telephone Connection Requirements

A plug and jack used to connect this equipment to the premises wiring and telephone network must comply with the applicable FCC Part 68 rules and requirements adopted by the ACTA. A compliant telephone cord and modular plug is provided with this product. It is designed to be connected to a compatible modular jack that is also compliant. See installation instructions for details.

#### Ringer Equivalence Number (REN)

The REN is used to determine the number of devices that may be connected to a telephone line. Excessive RENs on a telephone line may result in the devices not ringing in response to an incoming call. In most but not all areas, the sum of RENs should not exceed five (5.0). To be certain of the number of devices that may be connected to a line, as determined by the total RENs, contact the local Telephone Company. For products approved after July 23, 2001, the REN for this product is part of the product identifier that has the format US:AAAEQ##TXXXX. The digits represented by ## are the REN without a decimal point (e.g., 03 is a REN of 0.3). For earlier products, the REN is separately shown on the label.

$$\text{REN} = 0.1\text{B}$$

#### Incidence of Harm

If this equipment (PC1404) causes harm to the telephone network, the telephone company will notify you in advance that temporary discontinuance of service may be required. But if advance notice is not practical, the telephone company will notify the customer as soon as possible. Also, you will be advised of your right to file a complaint with the FCC if you believe it is necessary.

#### Changes in Telephone Company Equipment or Facilities

The Telephone Company may make changes in its facilities, equipment, operations or procedures that could affect the operation of the equipment. If this happens the Telephone Company

will provide advance notice in order for you to make necessary modifications to maintain uninterrupted service.

#### Equipment Maintenance Facility

If trouble is experienced with this equipment (PC1404) for repair or warranty information, contact the facility indicated below. If the equipment is causing harm to the telephone network, the Telephone Company may request that you disconnect the equipment until the problem is solved. This equipment is of a type that is not intended to be repaired by the end user.

**DSC c/o APL Logistics 757 Douglas Hill Rd., Lithia Springs, GA 30122**

#### Additional Information

Connection to party line service is subject to state tariffs. Contact the state public utility commission, public service commission or corporation commission for information.

Alarm dialing equipment must be able to seize the telephone line and place a call in an emergency situation. It must be able to do this even if other equipment (telephone, answering system, computer modem, etc.) already has the telephone line in use. To do so, alarm dialing equipment must be connected to a properly installed RJ-31X jack that is electrically in series with and ahead of all other equipment attached to the same telephone line. Proper installation is depicted in the figure below. If you have any questions concerning these instructions, you should consult your telephone company or a qualified installer about installing the RJ-31X jack and alarm dialing equipment for you.

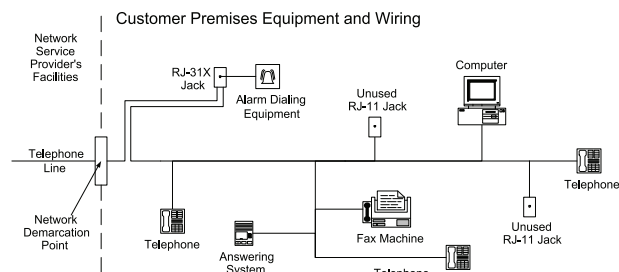

#### INDUSTRY CANADA STATEMENT

**NOTICE:** This product meets the applicable Industry Canada technical specifications. Le présent matériel est conforme aux spécifications techniques applicables d'Industrie Canada.

The Ringer Equivalence Number (REN) for this terminal equipment is 0.1. L'indice d'équivalence de la sonnerie (IES) du présent matériel est de 0.1.

The Ringer Equivalence Number is an indication of the maximum number of devices allowed to be connected to a telephone interface. The termination on an interface may consist of any combination of devices subject only to the requirement that the sum of the RENs of all the devices does not exceed five.

L'indice d'équivalence de la sonnerie (IES) sert à indiquer le nombre maximal de terminaux qui peuvent être raccordés à une interface téléphonique. La terminaison d'une interface peut consister en une combinaison quelconque de dispositifs, à la seule condition que la somme d'indices d'équivalence de la sonnerie de tous les dispositifs n'exécède pas 5.

The term "IC:" before the radio certification number only signifies that Industry Canada technical specifications were met.

Certification Number:

IC:160A-PC1404

This Class B digital apparatus complies with Canadian ICES-003.

Cet appareil numérique de la classe B est conforme à la norme NMB-003 du Canada.

## SIA False Alarm Reduction Installations

### Caution

Call Waiting Cancel (Section [382], Option 4) feature on a non-Call Waiting line will prevent successful communication to the supervising station.

### Notes

Programming at installation may be subordinate to other UL requirements for the intended application.

Cross zones have the ability to individually protect the intended area (e.g. motion detectors which overlap).

Cross zoning is not recommended for line security Installations nor is to be implemented on exit/entry zones.

There is a communication delay of 30 seconds in this control panel. It can be removed, or it can be increased up to 45 seconds at the option of the end user by consulting with the installer.

Do not duplicate any reporting codes. This applies for all communication formats other than SIA or CID sending automatic programmed reporting codes.

The security system shall be installed with the sounding device activated and the communicator enabled for transmission using SIA or CID format.

SIA Feature Programming Section	Comments	Range/Default	Requirement
<b>Exit Time</b> [005], 3rd entry	Access to Entry and Exit delays and Bell Time Out for the system	<b>Range:</b> 45- 255 seconds <b>Default:</b> 60 sec.	Required (programmable)
<b>Exit Time Restart</b> [018], Option 7 ON	Enables the exit delay restart feature	<b>Default:</b> Enabled	Required
<b>Auto Stay Arm on Un-vacated Premises</b> [001] Zone type 05, 06, 32	Function Key: Stay Arming. All Stay/Away type zones (05, 06, 32) will be automatically bypassed	If no exit after full arm <b>Default:</b> Enabled	Required
<b>Entry delay(s)</b> [005], 1st and 2nd entry	Access to Entry and Exit delays and Bell Time Out for the system <b>Note:</b> Combined Entry delay and Communications Delay (Abort Window) shall not exceed 60s	<b>Range:</b> 30 sec. to 4 min. <b>Default:</b> 30 sees	Required (programmable)
<b>Abort Window for Non-Fire zones</b> [101]-[108] bit 7 ON	Access to zone attributes, i.e., swinger shutdown, transmission delay and cross zone. Individual zones attribute bit 7 (Transmission delay) is by default ON	May be disabled by zone or zone type <b>Default:</b> Enabled	Required
<b>Abort Window Time - for Non-Fire zones</b> [377], 4th entry	Access to the programmable delay before communicating alarms <b>Note:</b> Combined Entry delay and Communications Delay (Abort Window) shall not exceed 60s	<b>Range:</b> 20 - 45 sec. <b>Default:</b> 30 sees	Required (programmable)
<b>Abort Annunciation</b> [382], Option 3 ON	Enables the "Communication Cancelled" message display on keypad	Annunciate that no alarm was transmitted <b>Default:</b> Enabled	Required
<b>Cancel Annunciation</b> [328], 8th entry	Access to the reporting code for Alarm Cancelled	Annunciate that a Cancel was transmitted <b>Default:</b> Enabled	Required
<b>Cancel Window</b> [377], 10th entry	When an access code is entered during the cancel window, a Communications Cancelled reporting code is sent.	<b>Range:</b> 005-255 min. <b>Default:</b> 000	Required
<b>Duress Feature</b> [*][5] Master Code Option 2 ON	Do not derive code from an existing Master/User code (e.g., Master code is 1234, the duress code should not be 1233 or 1235)	No 1+/- derivative of another user code. No duplicates with other user codes <b>Default:</b> disabled	Allowed
<b>Cross Zoning</b> [018] Option 6 [101]-[108] bit 8 OFF	This option enables Cross Zoning for entire system. Individual zones can be enabled for Cross zoning via Zone attribute bit 8 in sections [101]-[108].	Programming required <b>Default:</b> Disabled	Required
<b>Cross Zone Timer</b> [176]	Access to the programmable Cross Zone timer	May program Range: 001-255 sec./min. <b>Default:</b> 60 seconds	Allowed
<b>Swinger Shutdown for Alarms</b> [377] 1st entry	Access to the swinger shutdown limit for zone alarms.	For all non-fire zones shut down at 1 to 6 trips <b>Default:</b> 2 trips	Required (programmable)
<b>Swinger Shutdown Enable</b> [101] - [108] bit 6 ON	Access to zone attributes, i.e., swinger shutdown, transmission delay and cross zone. Individual zones attribute bit 6 (Swinger shutdown enabled) is by default ON	For non-police response zones <b>Default:</b> Enabled	Allowed
<b>24-Hr. Auto-verified Fire</b> [001] Zone type 29	Access to 24-Hr. Auto-verified Fire	Activates if a restore is not received within the specified time <b>Default:</b> Disabled	Required
<b>Call Waiting Cancel Dial String</b> [304], [382], Option 4 OFF	Access to the dialing sequence used to disable call waiting	Dependant on user phone line <b>Default:</b> disabled	Required

<b>System Test:</b> [*][6] Master Code, Option 4	The system activates all keypad sounders, bells or sirens for 2 seconds and all keypad lights turn on. Refer to the <i>User Manual (part no. 29008014)</i> .		
<b>Alarm Communications During Walk Test</b> [382] Option 2	Enables communication of zone alarms while Walk Test is active.		
<b>Walk Test End and Begin Reporting Codes</b> [348], 1 <sup>st</sup> and 2 <sup>nd</sup> Entries	Access to the reporting codes for Walk Test Begin and Walk Test End.		

**This product has been tested and found in compliance with the following standards:**

UL1023 Household Burglar-Alarm System Units

UL985 Household Fire Warning System Units

UL1635 Digital Alarm Communicator System Units

ULC-S545-02 Residential Fire Warning System Control Units

ORD-C1023-1974 Household Burglar-Alarm System Units

This product has also been tested and found in compliance with the ANSI/SIA CP-01-2010 Control Panel Standard – Features for False Alarm Reduction.

This product is UL/ULC listed under the following categories:

UTOU/UTOUC Control Units and Accessories, Household System Type

NBSX/NBSXC Household Burglar Alarm System Units

AMTB Control Panels, SIA False Alarm Reduction

The product is labeled with the UL and ULC listing marks along with the SIA CP-01-2010 compliance statement (also Classified in accordance with the SIA-CP-01-2010 Standard) as proof of compliance with the above-mentioned standards. For further information on this product's listings, please also refer to the official listing guides published at the UL web site ([www.ul.com](http://www.ul.com)) under the Certifications Section.

UL/ULC Residential Fire and Burglary Installations:

For ULC Installations refer to the Standard for the Installation of Residential Fire Warning Systems, CAN/ULC-S540.

- All burglary-type zones shall be configured with SEOL, DEOL, or zone-doubling configuration.

(Refer to section [101] to [108]; bit 15 or 16 shall be ON. See also section [13] options 1, 2, and 7).

- Use at least one Smoke Detector for Fire Installations (refer to section [001]; fire zone shall be programmed as type 08 or 29 (fire verified)).

- The entry delay shall not exceed 60 seconds. (Refer to section [005].)

- The exit delay shall not exceed 120 seconds. (Refer to section [005].)

- The minimum Bell Time-out is 4 minutes. (Refer to section [005].)

**Note:** For ULC Residential Fire Installations the minimum Bell Time-out is 5 minutes.

- Temporal Three Fire Signal shall be enabled. (Refer to section [013]; option 8 shall be ON.)

- A code shall be required for bypassing. (Refer to section [015]; option 5 shall be ON.)

- Trouble beeps shall be enabled. (Refer to section [023]; option 7 shall be OFF.)

- AC trouble indication LED shall be enabled. [Refer to Keypad Programming (PK/RFK keypads only), section [077]; options 5 and 6 shall be ON.]

- DACT Communicator shall be enabled for Supervising Station Monitoring. (Refer to section [380]; option 1 shall be ON.)

**Note:** The DACT communicator for this product has no line security.

- Telephone Line Monitoring (TLM) shall be enabled (refer to section [015]; option 7 shall be ON)

**Note:** This product is programmed to perform 5 attempts for communication of an event to the supervising station. If unsuccessful, a Fail To Communicate (FTC) trouble is generated.

- Test transmission cycle shall be set for monthly transmission (refer to section [377])

**Note:** For ULC Residential installations set for daily test transmission.

**Programming**

The notes in the programming sections describing the system configurations for UL/ULC listed installations shall be implemented.

**Bell Location**

The alarm sounding device (bell) shall be located where it can be heard by the person operating the security system during the daily arming and disarming cycle.

**Casual Users**

The installer should caution the user(s) not to give system information (e.g. codes, bypass methods, etc.) to casual users (baby-sitters or service people). Only the One-Time Use codes shall be given to casual users.

**User Information**

The installer should advise the users and note in the User's Manual:

- Service organization name and telephone number
- The programmed exit time
- The programmed entry time
- Test system weekly

**Note:** Remote arming or downloading is not applicable in UL installations.

## Appendix D: New Zealand Addendum

The following are programming defaults for New Zealand that differ from the standard defaults in this manual:

### 2.2 AC Terminals (pg. 3)

For New Zealand, use the following plug-in Transformer: energy-efficient, input 230-240VAC/50Hz, output 16VAC 1.5A, 1.8m 2-wire output lead; Tyco PN 88014330.

### 2.2 Telephone Line Wiring (pg. 4)

For New Zealand, wire the incoming and outgoing lines to the connection terminals of an appropriate, locally approved, telco connection outlet.

## Defaults

Section	Pg.	Description	Option	New Zealand Default
[001]	16	Zone 1-8 Definitions	Zones 5, 6, 7, 8	03
[013]	18	First System Options	Option 6, Audible Exit Fault Enable	OFF
[168]	21	Set Clock Forward (Daylight Saving)	Month	009
			Week	005
[169]	21	Set Clock Back (Standard Time)	Month	004
			Hour	003
[320]	22	Alarm Reporting Codes, Zones 01-08		11
[329]	23	Priority Alarm and Restore Reporting Codes	Keypad [F], [A], and [P] Alarms, and Aux. Input Alarm	11
[341]	23	Miscellaneous Closing (Arming) Reporting Codes	Automatic Zone Bypass	FF
[350]	24	Communicator Format Options	Telephone# 1-4	03
[367]	25	Opening/Closing Communicator Call Directions	Option 1, First Telephone Number	ON
[377]	25	Communication Variables	AC Failure Communication Delay	010
			Test Transmission Cycle (land line)	001
[380]	25	First Communicator Options	Option 6, Alternating Backup Dial	ON
[501]	27	PGM 1 Attributes	Opt. 5 Code Req.	OFF
[501]-[514], [551]-[564]	27	PGM Attributes	19 Command Output # 1 (*71), Opt. 5 Code Req.	OFF
[701]	29	First International Options	Option 1, 50 Hz AC	ON

## Appendix E: Australian Addendum

The following are programming defaults for Australia that differ from the standard defaults in this manual:

### 2.2 AC Terminals (pg. 3)

For Australia, use the following plug-in Transformer: energy-efficient, input 230-240VAC/50Hz, output 16VAC 1.5A, 1.8m 2-wire output lead; Tyco PN 88014330.

### 2.2 Telephone Line Wiring (pg. 4)

For Australia, wire the incoming and outgoing lines to the connection terminals of an appropriate, locally approved, telco connection outlet.

### Defaults

Section	Pg	Description	Option	Australian Default
[005] Subsect. [01]	17	System Times	Exit Delay	060
[005] Subsect. [09]	17	System Times	Bell Time-out (BTO)	005
[009]	17	Main Board PGM Output Programming	Onboard PGM 1 Type	03
[013]	18	First System Options	Option 3, Panel Shows all Troubles while Armed/ Panel Shows only Fire Troubles while Armed	OFF
[017]	19	Fifth System Options	Option 6, Daylight Savings Time Enabled/Daylight Savings Time Disabled	ON
[018]	19	Sixth System Options	Option 7, Exit Delay Restart Enabled/Exit Delay Restart Disabled	ON
[023]	19	Tenth System Options	Option 5, Switching from Away to Stay Disabled/Away to Stay Toggle Option Permitted	ON
[101]-[108]	20	Zone Attributes Defaults	01-02, Attribute 5 (Force Arming)	ON
			07-11, Attribute 6 (Swinger Shutdown)	ON
			13-17, Attribute 6 (Swinger Shutdown)	ON
			19-21, Attribute 6 (Swinger Shutdown)	ON
			26 24-Hr. Non-Alarm, Attribute 6 (Swinger Shutdown)	ON
[168]	21	Daylight Savings Time Begins	Month	010
			Week	005
[169]	21	Daylight Savings Time Ends	Month	003
			Week	005
[170]	21	PGM Output Timer		002
[320] [324]	and 22	Alarm (Restore) Reporting Codes, Zones 01-08		3A
[328]	22	Miscellaneous Alarm Reporting Codes	Duress Alarm	21
			Opening after Alarm	58
			Recent Closing	59
			Cross Zone/Police Code Alarm	4A
			Burglary Not Verified	78
			Alarm Cancelled	A6
[329]	23	Priority Alarm and Restore Reporting Codes	Keypad [F] Fire Alarm	1A
			Keypad [A] Auxiliary Alarm	AA
			Keypad [P] Panic Alarm	2A
			Auxiliary Input Alarm	4A
			Keypad [F] Fire Restore	1A
			Keypad [A] Auxiliary Restore	AA
			Keypad [P] Panic Restore	2A
			Auxiliary Input Restore	4A
[330]-[334]	23	Tamper (Restore) Reporting Codes, Zones 01-08		44
[338]	23	Miscellaneous Tamper Reporting Codes	General System Tamper/Restore	45
			Keypad Lockout	61

Section	Pg	Description	Option	Australian Default
[339]-[340]	23	Closing (Arming) Reporting Codes, Access Codes 1-32		A1
[341]	23	Miscellaneous Closing (Arming) Reporting Codes	Partial Closing	56
			Special Closing	AA
			Late to Close	54
			Exit Fault	74
[342]-[343]	23-24	Opening (Disarming) Reporting Codes, Access Codes 1-32		A1
[344]	24	Miscellaneous Opening (Disarming) Reporting Codes	Auto-Arm Cancel/Postpone	55
			Special Opening	AA
[345]	24	Maintenance Alarm Reporting Codes	Battery Trouble Alarm	A2
			AC Failure Trouble Alarm	A1
			Bell Circuit Trouble Alarm	21
			Fire Trouble Alarm	73
			Auxiliary Power Supply Trouble Alarm	12
			General System Trouble	AA
			General System Supervisory	3A
[346]	24	Maintenance Alarm Restore Reporting Codes	Battery Trouble Restore	A2
			AC Failure Trouble Restore	A1
			Bell Circuit Trouble Restore	21
			Fire Trouble Restore	73
			Auxiliary Power Supply Trouble Restore	12
			TLM Restore	51
			General System Trouble Restore	AA
			General System Supervisory Restore	33
[347]	24	Misc. Maintenance Reporting Codes	Telephone #1-2 FTC Restore	54
			DLS Lead in and Lead out	FF
			General Zone Fault Alarm	80
			General Zone Fault Restore	80
			Delinquency Reporting Code	54
			Installer Lead in and Lead out	FF
			Telephone #3-4	54
[348]	24	Test Transmission Reporting Codes	Walk Test End/Walk Test Begin	A7
			Periodic Test Transmission	A2
			System Test	A1
[350]	24	Communicator Format Options	1st to 4th Telephone Numbers	03
[367]	25	Opening/Closing Comm. Call Directions	Option 1, First Telephone Number	ON
[377]	25	Communication Variables	Test transmission cycle (land-line)	007
[378]	25	Test Transmission Time of Day		0300
[380]	25	First Communicator Option	Option 2, Restores on Bell Time-out/Restores Follow Zones	ON
			Option 6, Alternate Backup Dialing Enabled/Call Primary Number, Backup to Secondary	ON
[501]	27	PGM 1 Attributes	Options 4, 5	OFF
[701]	29	First International Options	Option 1, 50 Hz AC/60 Hz AC	ON
[702]	29	Second International Options	Option 1, Pulse Dialing Make/Break Ratio is 33/67/ Pulse Dialing Make/Break Ratio is 40/60	ON

## Appendix F: Addendum for Installations in South Africa

The following are programming defaults for South Africa that differ from the standard defaults in this manual:

### Defaults

Section	Pg.	Description	Option	South African Default
[005] Subsect. [01]	17	System Times	Exit Delay	045
[005] Subsect. [09]	17	System Times	Bell Time-out (BTO)	003
[009]	17	Main Board PGM Output Programming	Onboard PGM 1 Type	10
[010]	17	PC5208 PGM Output Programming	PGM 3 and PGM 4	05   30
[013]	18	First System Options	Option 5, Auto-Arm Schedule in [*][6] + Installer Prog./ Auto-Arm Schedule in Installer Prog. Only	OFF
			Option 6, Audible Exit Fault Enabled/Audible Exit Fault Disabled	OFF
[015]	18	Third System Options	Option 2, [P] Key Audible (Bell/Beeps)/[P] Key Silent	ON
			Option 7, TLM Enabled/TLM Disabled	OFF
[016]	18	Fourth System Options	Option 2, Trouble Light Flashes if AC Fails/Trouble Light Does not Flash	ON
[018]	19	Sixth System Options	Option 5, Keypad Buzzer Follows Bell Enabled/Keypad Buzzer Follows Bell Disabled	ON
[168]	21	Daylight Savings Time Begins	Month	004
			Week	001
[169]	21	Daylight Savings Time Ends	Month	010
			Week	005
[328]	22	Miscellaneous Alarm Reporting Codes	Recent Closing	00
			Burglary Not Verified	00
[341]	23	Miscellaneous Closing (Arming) Reporting Codes	Automatic Zone Bypass	FF
			Late to Close	00
[347]	24	Misc. Maintenance Reporting Codes	DLS Lead in and Lead out	FF
			Installer Lead in and Lead out	FF
[350]	24	Communicator Format Options	1st to 4th Telephone Numbers	03
[367]	25	Opening/Closing Comm. Call Directions	Option 1, First Telephone Number	ON
[377]	25	Communication Variables	Swinger Shutdown (Alarm and Rest)	004
			TLM Trouble Delay	040
[380]	25	First Communicator Option	Option 6, Alternate Backup Dialing Enabled/Call Primary Number, Backup to Secondary	ON
[501]	27	PGM 1 Attributes	Options 1, 2, 6-8	ON
[502]	27	PGM 2 Attributes	Option 8	ON
[501]-[514]; [551]-[564]	28	10 System Event (with Event Options)	Option 8, Output Follows PGM Timer	ON
[701]	29	First International Options	Option 1, 50 Hz AC/60 Hz AC	ON
[702]	29	Second International Options	Option 1, Pulse Dialing Make/Break Ratio is 33/67/ Pulse Dialing Make/Break Ratio is 40/60	ON

## Europe



This product is in conformity with:

**EMC Directive 2004/108/EC** based on results using harmonized standards in accordance with article 10(5),

**R&TTE Directive 1999/5/EC** based on following Annex III of the directive and

**LVD Directive 2006/95/EC** based on results using harmonized standards.

The product is labelled with the CE mark as proof of compliance with the above mentioned European Directives. Also a CE declaration of conformity (DoC) for this product can be found at [www.dsc.com](http://www.dsc.com) under Agency Listings section.

Hereby, DSC, declares that this device is in compliance with the essential requirements and other relevant provisions of Directive 1999/5/EC.

The complete R&TTE Declaration of Conformity can be found at [http://www.dsc.com/listings\\_index.aspx](http://www.dsc.com/listings_index.aspx)

(CZE) DSC jako výrobce prohlašuje, že tento výrobek je v souladu se všemi relevantními požadavky směrnice 1999/5/EC.

(DAN) DSC erklærer herved at denne komponenten overholder alle vigtige krav samt andre bestemmelser gitt i direktiv 1999/5/EC.

(DUT) Hierbij verklaart DSC dat dit toestel in overeenstemming is met de eisen en bepalingen van richtlijn 1999/5/EC.

(FIN) DSC vakuuttaa laitteen täyttävän direktiivin 1999/5/EC olennaiset vaatimukset.

(FRE) Par la présente, DSC déclare que ce dispositif est conforme aux exigences essentielles et autres stipulations pertinentes de la Directive 1999/5/EC.

(GER) Hierdurch erklärt DSC, daß dieses Gerät den erforderlichen Bedingungen und Voraussetzungen der Richtlinie 1999/5/EC entspricht.

(GRE) Διὰ τοῦ παρόντος, ἡ DSC, δηλώνει ὅτι αὐτὴ ἡ συσκευή εἶναι σύμφωνα με τὴν οὐσιώδη ἀπαιτῆσις καὶ με ὅλες τὴς ἄλλες σχετικὲς ἀναφορὲς τῆς Οδηγίας 1999/5/EC.

(ITA) Con la presente la Digital Security Controls dichiara che questo prodotto è conforme ai requisiti essenziali ed altre disposizioni rilevanti relative alla Direttiva 1999/05/CE.

(NOR) DSC erklærer at denne enheten er i samsvar med de grunnleggende krav og øvrige relevante krav i direktiv 1999/5/EF.

(POL) DSC oświadcza, że urządzenie jest w zgodności z zasadniczymi wymaganiami oraz pozostałymi stosownymi postanowieniami Dyrektywy 1999/5/WE.

(POR) Por este meio, a DSC, declara que este equipamento está em conformidade com os requisitos essenciais e outras determinações relevantes da Directiva 1999/5/EC.

(SPA) Por la presente, DSC, declara que este equipo está en conformidad con los requisitos esenciales y otros requisitos relevantes de la Directiva 1999/5/EC.

(SWE) DSC bekräftar härmed att denna apparat uppfyller de väsentliga kraven och andra relevanta bestämmelser i Direktivet 1999/5/EC.



© 2013 Tyco International Ltd. and its Respective Companies. All Rights Reserved.

The trademarks, logos, and service marks displayed on this document are registered in the United States [or other countries]. Any misuse of the trademarks is strictly prohibited and Tyco International Ltd. will aggressively enforce its intellectual property rights to the fullest extent of the law, including pursuit of criminal prosecution wherever necessary. All trademarks not owned by Tyco International Ltd. are the property of their respective owners, and are used with permission or allowed under applicable laws.

Product offerings and specifications are subject to change without notice. Actual products may vary from photos. Not all products include all features. Availability varies by region; contact your sales representative.

# DSC

A Tyco International Company

Technical Support: 1-800-387-3630 (Can/US)  
905-760-3000 (Intl.) [www.dsc.com](http://www.dsc.com)  
Printed in Canada



29008503R001